



G3 + PERUZZO  
LIVE YOUR EMOTIONS



CATALOGO GENERALE GENERAL CATALOGUE

Vivere in Movimento *Life in Motion*

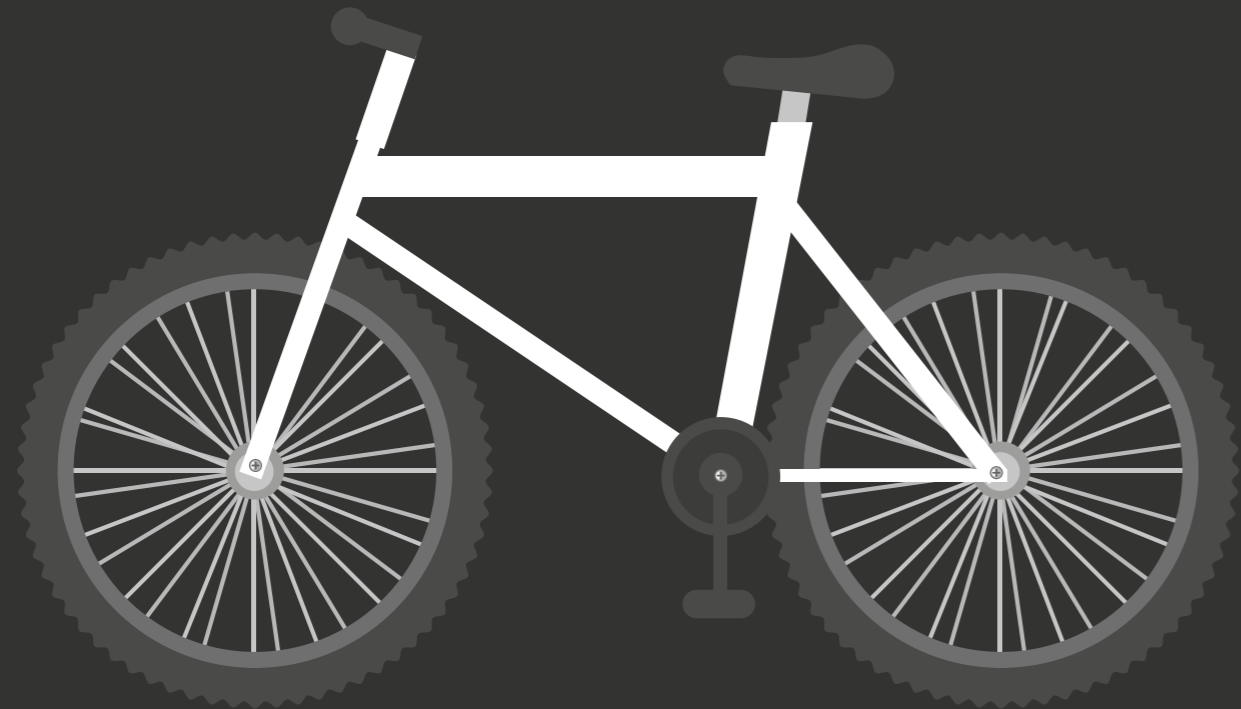

**Peruzzo** <sup>100% MADE IN ITALY</sup> ®



Via Meucci 115 - 36028 Rossano Veneto (VI) Italy

[www.peruzzosrl.com](http://www.peruzzosrl.com)

## Un po' di noi...

Peruzzo srl è stata fondata nel 1972. All'epoca il core-business era la produzione di copricatena per bici. L'innovazione, la creatività e la qualità dei prodotti, hanno reso l'azienda leader europeo per questo articolo. L'avvento delle MTB alla fine degli anni '80 ha drasticamente contratto la richiesta di carter. Da qui nasce l'intuizione di convertire la produzione in accessori ciclo, con partico-

lare focus ai portabici per auto. Oggi Peruzzo srl è un brand riconosciuto a livello europeo per la produzione di prodotti di qualità, 100% made in Italy, fortemente orientati alle necessità degli appassionati del ciclismo.

## About us...

Peruzzo srl was founded in 1972, it started of making chain covers for bicycles, becoming leader in this sector in Europe through innovation, creativity and focus on quality. The arrival of MTB bicycles in the 1980's was the catalyst for Peruzzo to expand into new product sectors, especially car cycle carriers.

Today Peruzzo is recognised as a European leader in the production of 100% made in Italy quality products, very much focused on the needs of cycling tifosi the world over.

**Peruzzo**  
100% MADE IN ITALY

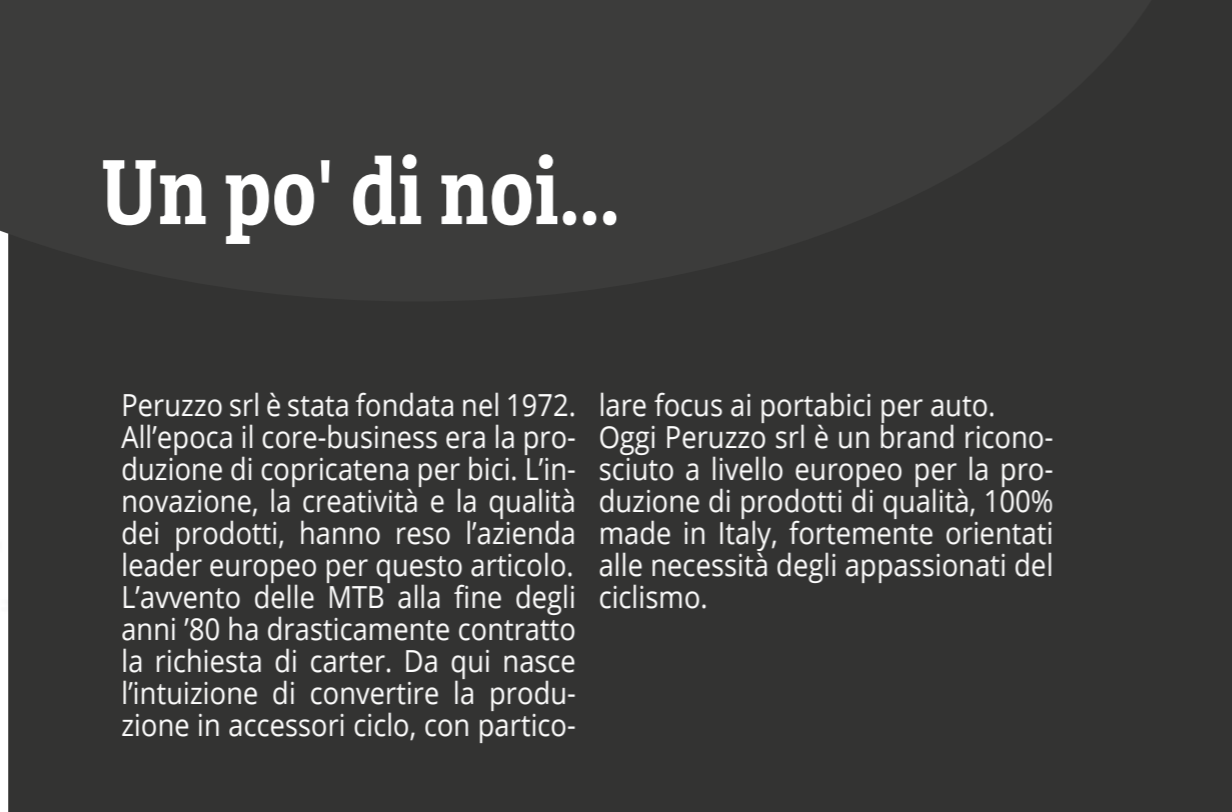

**Petruzzzo**<sup>®</sup>  
100% MADE IN ITALY

**Legenda Portabici Bike carrier legend**

**Portabici da gancio traino Tow ball bike carrier**

**Portabici da tetto Roof mounted bike carrier**

**Portabici posteriore Rear bike carrier**

**Portabici 4x4 4x4 bike carrier**



# Legenda Portabici Bike carrier legend

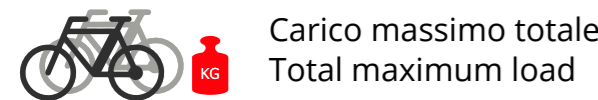

Carico massimo totale  
Total maximum load



Idoneo per FAT bikes  
FAT bikes friendly



Numero massimo bici  
Maximum bikes



Idoneo per E-bikes  
E-bikes friendly



Interasse massimo ruote bici  
Max distance between bike wheels



Interasse tubi appoggio telaio  
Distance between tube arms for bike frame support



Numero massimo sci  
Maximum ski



Numero massimo snowboard  
Maximum snowboard number



Inclinabile  
Tiltable



Misure  
Sizes



Larghezza massima ruota  
Maximum tyre width



Dimensione massima bici  
Maximum bike size



Dimensione massima sezione telaio  
Maximum size frame section



Dimensioni massime barra portatutto  
Maximum carry bar width



Il prodotto è omologato secondo direttiva europea  
Full european homologation product



City Crash Test

## Ricambi e accessori Spare parts and accessories

Per informazioni aggiornate e per l'acquisto di parti di ricambio vi invitiamo a visitare il sito [www.peruzzosrl.com](http://www.peruzzosrl.com)  
For up-dated information and for buying spare parts we invite you to visit [www.peruzzosrl.com](http://www.peruzzosrl.com)



**Peruzzo**  
100% MADE IN ITALY

# Portabici da gancio traino Tow - ball bike carriers

---

Vivere in movimento *Life in motion*



# Portabici Bike carriers

Portabici da gancio traino / Tow - ball bike carriers

## ZEPHYR - 713E (2 BICI / 2 BIKES)



**COMPLETAMENTE ASSEMBLATO**  
Fully assembled

**POMELLI CON CHIAVE INCLUSI**  
Lockable bracket with key included

**DOTATO DI RAMPA DI CARICO**  
Equipped with bike loading ramp

**PEDALE AMPIO DI INCLINAZIONE**  
Wide pedal for tilting

**INTERASSE MAGGIORATO TRA I BINARI (25 CM)**  
Wider spacing between rails (25 CM)



# Caratteristiche Features

HOMOLOGATED ✓

**Peruzzo**  
100% MADE IN ITALY



**MATERIALE/MATERIAL**  
Alluminio/Aluminum

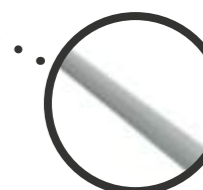

**NR**   
2

  
125 CM

  
7 CM

  
12" - 29"

  
TOT = 60 KG

  
110 x 64 x 77 CM

 **eBIKE**  
  
✓



# Portabici Bike carriers

Portabici da gancio traino / Tow - ball bike carriers

## ZEPHYR - 713/3E (3 BICI / 3 BIKES)

**COMPLETAMENTE ASSEMBLATO**  
Fully assembled

**POMELLI CON CHIAVE INCLUSI**  
Lockable bracket with key included

**DISPONIBILE KIT ACCESSORIO PER LA 4° BICI**  
Kit for the 4th bike available as accessory

**DOTATO DI RAMPA DI CARICO**  
Equipped with bike loading ramp

**INTERASSE MAGGIORATO TRA I BINARI (25 CM)**  
Wider spacing between rails (25 CM)

**PEDALE AMPIO DI INCLINAZIONE**  
Wide pedal for tilting



# Caratteristiche Features

HOMOLOGATED ✓

100% MADE IN ITALY  
**Peruzzo**

**MATERIALE/MATERIAL**  
Alluminio/Aluminum



3  
(4 con kit art 873 / 4 with kit art 873)



125 CM



7 CM



12" - 29"



TOT = 60 KG



110 x 89 x 77 CM

eBIKE





# Portabici Bike carriers

Portabici da gancio traino / Tow - ball bike carriers

## PURE INSTINCT - 708 (2 BICI / 2 BIKES)

COMPLETAMENTE ASSEMBLATO  
Fully assembled

LUCCHETTO CON CHIAVE  
PER CHIUSURA BICI  
Locking cable for bikes

BINARI E PORTATARGA  
RICHIUDIBILI  
Folding rails and plate holder

CINGHIE E BLOCCA RUOTA  
CON CRICCHETTO  
Wheel straps with ratchets

INTERASSE MAGGIORATO TRA I BINARI (25 CM)  
Increased gap between rails  
(25 CM)



# Caratteristiche Features

HOMOLOGATED ✓

MATERIALE/MATERIAL  
Acciaio/Steel



NR   
2

  
120 CM

  
10 CM

  
12" - 29"

   
TOT = 60 KG

  
28 x 61 x 63 CM  
(chiuso/closed)  
58 x 110 x 63 CM  
(aperto/open)

 BIKE  
  
✓

FAT  
  
✓





**“Niente è paragonabile al semplice piacere di un giro in bicicletta”**

Nothing compares to the simple pleasure of a bicycle ride

**(J. F. KENNEDY)**



# Portabici Bike carriers

Portabici da gancio traino / Tow - ball bike carriers

**PURE INSTINCT - 708/3**  
(3 BICI / 3 BIKES)

**COMPLETAMENTE ASSEMBLATO**  
Fully assembled

**CINGHIE E BLOCCA RUOTA CON CRICCHETTO**  
Wheel straps with ratchets

**LUCCHETTO CON CHIAVE PER CHIUSURA BICI**  
Locking cable for bikes

**BINARI E PORTATARGA RICHIUDIBILI**  
Folding rails and plate holder



# Caratteristiche Features

HOMOLOGATED ✓

Peruzzo 100% MADE IN ITALY

**MATERIALE/MATERIAL**  
Acciaio/Steel



**NR**   
3

  
120 CM

  
10 CM

  
12" - 29"

  
TOT = 60 KG

  
28 x 61 x 75 CM  
(chiuso/closed)  
58 x 110 x 75 CM  
(aperto/open)

**FAT**   
✓



# Portabici Bike carriers

Portabici da gancio traino / Tow - ball bike carriers

**PURE INSTINCT - 708/4**  
(4 BICI / 4 BIKES)

**COMPLETAMENTE ASSEMBLATO**  
Fully assembled

**CINGHIE E BLOCCA RUOTA CON CRICCHETTO**  
Wheel straps with ratchets

**LUCCHETTO CON CHIAVE PER CHIUSURA BICI**  
Locking cable for bikes

**BINARI E PORTATARGA RICHIUDIBILI**  
Folding rails and plate holder



# Caratteristiche Features

HOMOLOGATED ✓

**Peruzzo** 100% MADE IN ITALY

**MATERIALE/MATERIAL**  
Acciaio/Steel



**NR**   
4

  
120 CM

  
10 CM

  
12" - 29"

  
TOT = 60 KG

  
28 x 61 x 92 CM  
(chiuso/closed)  
58 x 110 x 92 CM  
(aperto/open)

**FAT**  
  
✓





**“La vita è come andare in bicicletta. Per restare in equilibrio devi muoverti.”**

Life is like riding a bicycle. To stay balanced, you have to move

**(A. EINSTEIN)**



# Portabici Bike carriers

Portabici da gancio traino / Tow - ball bike carriers

**PARMA - 706**  
(2 BICI / 2 BIKES)



**PRIMO PREZZO PER PORTABICI  
CON SGANCIO RAPIDO**  
Great value carrier  
for quick release system

**SISTEMA DI AGGANCIO RAPIDO**  
Quick and easy to fit

**INCLINABILE PER FACILITARE  
IL CARICO POSTERIORE**  
Tiltable system for an easy access  
to the trunk

# Caratteristiche Features

HOMOLOGATED ✓



**MATERIALE/MATERIAL**  
Acciaio/Steel



**NR**   
2

  
120 CM

  
8 CM

  
12" - 29"

  
TOT = 60 KG

  
61 x 109 x 54 CM



# Portabici Bike carriers

Portabici da gancio traino / Tow - ball bike carriers

**PARMA - 706/3**  
(3 BICI / 3 BIKES)



**PRIMO PREZZO PER PORTABICI  
CON SGANCIO RAPIDO**  
Entry price for quick release system

**SISTEMA DI AGGANCIO RAPIDO**  
Quick and easy to fit

**INCLINABILE PER FACILITARE  
IL CARICO POSTERIORE**  
Tiltable system for an easy access  
to the trunk

# Caratteristiche Features

HOMOLOGATED ✓



**MATERIALE/MATERIAL**  
Acciaio/Steel

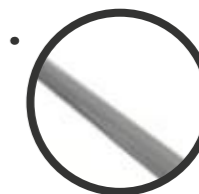

**NR**   
3

  
120 CM

  
8 CM

  
12" - 29"

  
TOT = 60 KG

  
61 x 109 x 70 CM



# Portabici Bike carriers

Portabici da gancio traino / Tow - ball bike carriers

**PARMA - 706/4**  
(4 BICI / 4 BIKES)



PRIMO PREZZO PER PORTABICI  
CON SGANCIO RAPIDO  
Entry price for quick release system

SISTEMA DI AGGANCIO RAPIDO  
Quick and easy to fit

INCLINABILE PER FACILITARE  
IL CARICO POSTERIORE  
Tiltable system for an easy access  
to the trunk

# Caratteristiche Features

HOMOLOGATED ✓



MATERIALE/MATERIAL  
Acciaio/Steel

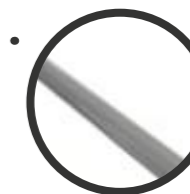

NR   
4

  
120 CM

  
8 CM

  
12" - 29"

  
TOT = 60 KG

  
61 x 109 x 90 CM







**“Il vero viaggio di scoperta non consiste nel cercare nuove terre,  
ma nell’averne nuovi occhi.”**

The real voyage of discovery does not consist in seeking new lands,  
but in having new eyes.

(M. PROUST)



# Portabici Bike carriers

Portabici da gancio traino / Tow - ball bike carriers

**SIENA - 668**  
(2 BICI / 2 BIKES)

**VERSIONE FISSA - 669**  
Fixed Version - 669

**PRIMO PREZZO PER PORTABICI OMOLOGATI**  
Value carrier fully approved and certified

**POGGIARUOTA AMPIO**  
Wide wheel holders

**DISPONIBILE ANCHE IN VERSIONE  
NON INCLINABILE (ART.669)**

Also available in not adjustable version, no tilt (art.669)

**INCLINABILE PER FACILITARE  
IL CARICO POSTERIORE**  
Tiltable system for an easy access  
to the trunk

# Caratteristiche Features

HOMOLOGATED ✓



**MATERIALE/MATERIAL**  
Acciaio/Steel

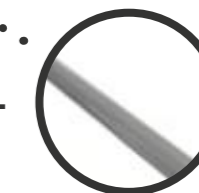

2



120 CM



8 CM



12" - 29"



TOT = 34 KG



61 x 109 x 53 CM



# Portabici Bike carriers

Portabici da gancio traino / Tow - ball bike carriers

**SIENA - 668/3**  
(3 BICI / 3 BIKES)

**VERSIONE FISSA - 669/3**  
Fixed Version - 669/3



**OTTIMO RAPPORTO QUALITA'- PREZZO**  
Good value for money

**POGGIARUOTA AMPIO**  
Wide wheel holders

**INCLINABILE PER FACILITARE IL CARICO POSTERIORE**  
Tiltable system for an easy access to the trunk

**DISPONIBILE ANCHE IN VERSIONE NON INCLINABILE (ART.669/3)**

Also available in not adjustable version, no tilt (art.669/3)

# Caratteristiche Features

HOMOLOGATED ✓



**MATERIALE/MATERIAL**  
Acciaio/Steel

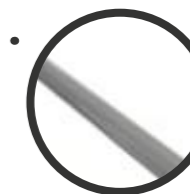

3



120 CM



8 CM



12" - 29"



TOT = 51 KG



61 x 109 x 70 CM



# Portabici Bike carriers

Portabici da gancio traino / Tow - ball bike carriers

**SIENA - 668/4**  
(4 BICI / 4 BIKES)



**OTTIMO RAPPORTO QUALITA'- PREZZO**  
Good value for money

**POGGIARUOTA AMPIO**  
Wide wheel holders

**INCLINABILE PER FACILITARE IL CARICO POSTERIORE**  
Tiltable system for an easy access to the trunk

# Caratteristiche Features

HOMOLOGATED ✓

100% MADE IN ITALY  
**Peruzzo**



**MATERIALE/MATERIAL**  
Acciaio/Steel

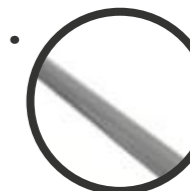

**NR**   
4

  
120 CM

  
8 CM

  
12" - 29"

   
TOT = 60 KG

  
61 x 109 x 90 CM





**"Il più bel viaggio, è quello che non è stato ancora fatto"**

The most beautiful journey is the one that has not been done yet

(L. PEYRON)



# Portabici Bike carriers

Portabici da gancio traino / Tow - ball bike carriers

**AREZZO - 667**  
(2 BICI / 2 BIKES)



**UNIVERSALE PER TUTTE LE BICI**  
Universal for any bike

**OTTIMO RAPPORTO QUALITA' - PREZZO**  
Good value for money

**INCLINABILE PER FACILITARE IL CARICO POSTERIORE**  
Tiltable system for an easy access to the trunk

# Caratteristiche Features

**Petuzzo**  
100% MADE IN ITALY



**MATERIALE/MATERIAL**  
Acciaio/Steel



2



MIN 34 CM



<6 CM



TUTTE  
ALL



TUTTE  
ALL



TOT = 30 KG



32 x 16 x 82 CM



# Portabici Bike carriers

Portabici da gancio traino / Tow - ball bike carriers

**AREZZO - 667/3**  
(3 BICI / 3 BIKES)



SISTEMA BLOCCABICI CON PROTEZIONE  
● AD EFFETTO AMMORTIZZATORE  
Shock absorbing frame support

UNIVERSALE PER TUTTE LE BICI  
Universal for any bike

INCLINABILE PER FACILITARE  
IL CARICO POSTERIORE  
Tiltable system for an easy access  
to the trunk

# Caratteristiche Features

**Petuzzo**  
100% MADE IN ITALY



MATERIALE/MATERIAL  
Acciaio/Steel



3



MIN 34 CM



<6 CM



TUTTE  
ALL



TUTTE  
ALL



TOT = 45 KG



32 x 16 x 82 CM



# Portabici Bike carriers

Portabici da gancio traino / Tow - ball bike carriers

**AREZZO - 667/4**  
(4 BICI / 4 BIKES)



SISTEMA BLOCCABICI CON PROTEZIONE  
AD EFFETTO AMMORTIZZATORE  
Shock absorbing frame support

UNIVERSALE, PER TUTTE LE BICI  
Universal, for any bike

OTTIMO RAPPORTO QUALITA' - PREZZO  
Good value for money

# Caratteristiche Features

**Petuzzo**  
100% MADE IN ITALY



MATERIALE/MATERIAL  
Acciaio/Steel



NR   
4

  
MIN 34 CM

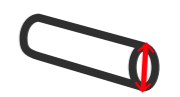
  
<6 CM

  
TUTTE  
ALL

  
TUTTE  
ALL

  
TOT = 50 KG

  
32 x 16 x 82 CM







# Portabici Bike carriers

Portabici da gancio traino / Tow - ball bike carriers

**CRUISING - 302**  
(2 BICI / 2 BIKES)

**FACILE DA MONTARE E SMONTARE**  
Quick and easy to fit and remove

**COMPATTO E SPACE SAVER**  
Compact and space saver



**UNIVERSALE PER IL TRASPORTO DI 2 BICI**  
Universal for two bikes loading

# Caratteristiche Features

**Petuzzo**  
100% MADE IN ITALY



**MATERIALE/MATERIAL**  
Acciaio/Steel



**NR**   
2

  
MIN 38 CM

  
<6 CM

  
TUTTE  
ALL

  
TUTTE  
ALL

  
TOT = 30 KG

  
79 x 24 x 35 CM



**Peruzzo**  
100% MADE IN ITALY



**Portabici da tetto**  
**Roof mounted bike carriers**

---

Vivere in movimento *Life in motion*

# Portabici Bike carriers

Portabici da tetto / Roof mounted bike carriers

## PURE INSTINCT ROOF - 710

**PINZA ROTANTE 360° (SISTEMA BREVETTATO)  
CHE CONSENTE IL FISSAGGIO SU PIU' PUNTI DEL TELAIO**  
360° rotation arm head (patented system)  
allows fixing of any frame

**FISSAGGIO UNIVERSALE AL TUBO  
SOTTO SELLA**  
Universal fixing point under saddle

**KIT FISSAGGIO CAVA A T INCLUSO**  
T section fixing kit included

**DOPPIA CHIUSURA A CHIAVE SIA PER LA BICI CHE  
PER IL PRODOTTO SULLE BARRE PORTATUTTO**  
Secure - locks bike to carrier and carrier to roof bars



# Caratteristiche Features

City✓Crash

100% MADE IN ITALY  
**Petuzzo**



**MATERIALE/MATERIAL**  
Alluminio/Aluminum



**NR**   
1

  
125 CM

  
2.2 CM < 5 CM

  
7 CM

  
<29"

  
TOT = 20 KG

  
142 x 30 x 11 CM

  
<8 CM

Per barre senza cava a T art.875  
For bars without T section art.875



# Portabici Bike carriers

Portabici da tetto / Roof mounted bike carriers

## LEVANTE - 730

**PINZA ROTANTE 360° (SISTEMA BREVETTATO)  
CHE CONSENTE IL FISSAGGIO SU PIU' PUNTI DEL TELAIO**  
360° rotation arm head (patented system)  
allows fixing of any frame

**FISSAGGIO UNIVERSALE AL TUBO  
SOTTO SELLA**  
Universal fixing point under saddle

**KIT FISSAGGIO CAVA A T INCLUSO**  
T section fixing kit included

**DOPPIA CHIUSURA A CHIAVE SIA PER LA BICI CHE  
PER IL PRODOTTO SULLE BARRE PORTATUTTO**  
Secure - locks bike to carrier and carrier to roof bars



# Caratteristiche Features

**Petuzzo** 100% MADE IN ITALY

**MATERIALE/MATERIAL**  
Alluminio/Aluminum

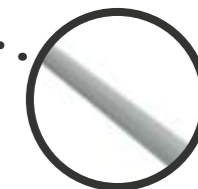

**NR**   
1

  
125 CM

  
2.2 CM < 5 CM

  
7 CM

  
<29"

  
TOT = 20 KG

  
142 x 30 x 11 CM

  
<8 CM

Per barre senza cava a T art.912  
For bars without T section art.912





**“La bicicletta è l’immagine visibile del vento.”**

The bicycle is the visible image of the wind.

(C. ANGELINI)



# Portabici Bike carriers

Portabici da tetto / Roof mounted bike carriers

**ROMA - 602**

**CHIUSURA A CHIAVE DELLA BICI AL PORTABICI**  
Clamp with locking between bike and bike carrier

**PINZA DI FISSAGGIO PER TELAI FINO A 7X9 CM**  
Clamp for frames up to 7x9 CM

**POGGIARUOTA ANTERIORE E POSTERIORE REGOLABILE**  
Adjustable wheel holders



# Caratteristiche Features

**Petuzzo** 100% MADE IN ITALY

**MATERIALE/MATERIAL**  
Alluminio/Aluminum



**NR**   
1

  
112 CM

  
7 CM  
7 x 9 CM

  
5.5 CM

  
<28"

  
TOT = 15 KG

  
138 x 24 x 9 CM

  
<7 CM

Per barre con cava a T art.364  
For bars with T section art.364



# Portabici Bike carriers

Portabici da tetto / Roof mounted bike carriers

## ROMA TANDEM - 604

**CHIUSURA A CHIAVE DELLA BICI AL PORTABICI**  
Clamp with locking between bike and bike carrier

**L'UNICO PRODOTTO SUL MERCATO IN GRADO DI TRASPORTARE BICI TANDEM**  
The only product which can load tandem bikes

**POGGIARUOTA ANTERIORE E POSTERIORE REGOLABILE**  
Adjustable wheel holders



# Caratteristiche Features

**Petuzzo** 100% MADE IN ITALY

**MATERIALE/MATERIAL**  
Alluminio/Aluminum

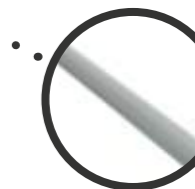

Per barre con cava a T art.364  
For bars with T section art.364





**“Adoro andare in bicicletta,  
vedo cose che altrimenti non avrei mai visto”**

I love to ride a bike,  
I see things that I would never have seen otherwise.

**(S. LITTLEWORD)**





# Portabici Bike carriers

Portabici da tetto / Roof mounted bike carriers

**MONZA - 682**



# Caratteristiche Features

City✓Crash

Petuzzo 100% MADE IN ITALY



**MATERIALE/MATERIAL**  
Alluminio/Aluminum

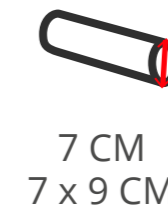
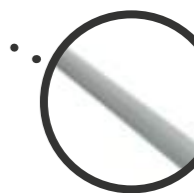

Per barre con cava a T art.364  
For bars with T section art.364



# Portabici Bike carriers

Portabici da tetto / Roof mounted bike carriers

**MISANO - 609**



# Caratteristiche Features

City✓Crash

**Petuzzo** 100% MADE IN ITALY



**MATERIALE/MATERIAL**  
Alluminio/Aluminum

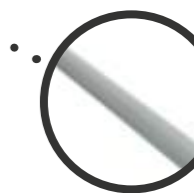

**NR**  
1

120 CM

6 CM  
6 x 10 CM

7 CM

<29"

TOT = 15 KG

142 x 20 x 7 CM

<7 CM

Per barre con cava a T art.364  
For bars with T section art.364



# Portabici Bike carriers

Portabici da tetto / Roof mounted bike carriers

**IMOLA - 319**



# Caratteristiche Features

City✓Crash

Petuzzo 100% MADE IN ITALY

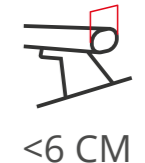
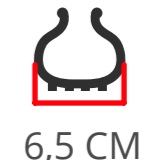
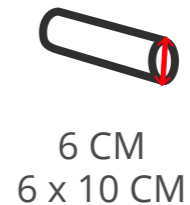
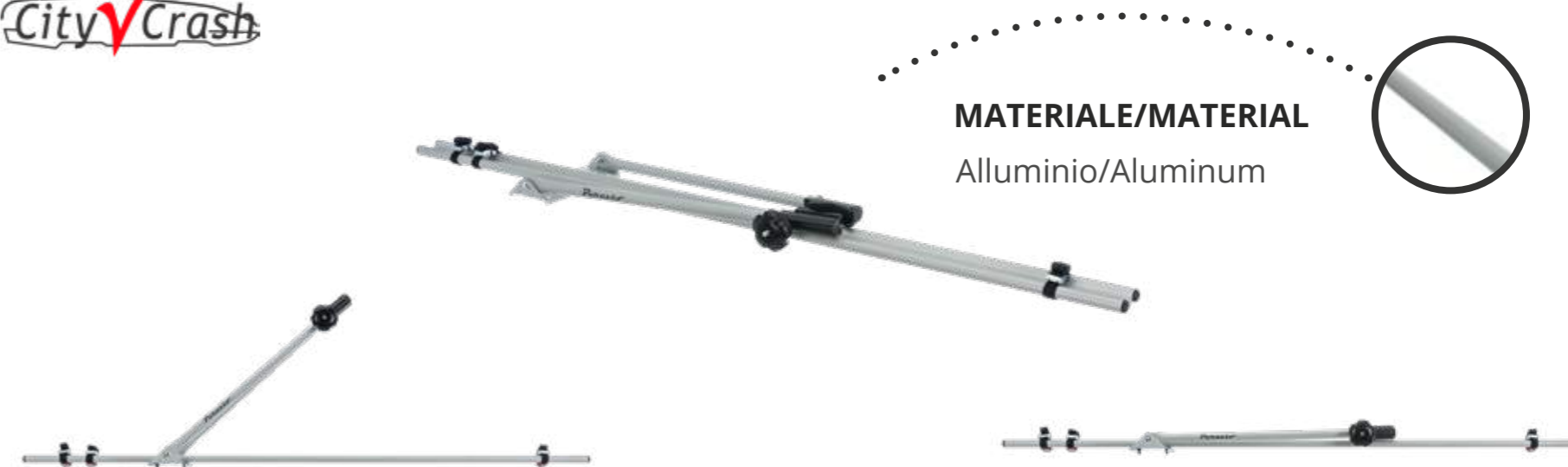

Per barre con cava a T art.364  
For bars with T section art.364





**“La bicicletta è la penna che scrive sull’asfalto.”**

The bicycle is the pen that writes on the asphalt.

(G. DEMAYSONCEL)



# Portabici Bike carriers

Portabici da tetto / Roof mounted bike carriers

**NAPOLI - 603**



**CHIUSURA A CHIAVE DELLA BICI AL PORTABICI**  
Clamp with locking between bike and bike carrier

**PINZA DI FISSAGGIO PER TELAI FINO A 7X9 CM**  
Clamp for frames up to 7x9 cm

**OTTIMO RAPPORTO QUALITA' - PREZZO**  
Good value for money

# Caratteristiche Features

**Petuzzo**  
100% MADE IN ITALY



**MATERIALE/MATERIAL**  
Acciaio/Steel



Per barre con cava a T art.364  
For bars with T section art.364



# Portabici Bike carriers

Portabici da tetto / Roof mounted bike carriers

**NAPOLI - 607**



# Caratteristiche Features

**Petuzzo** 100% MADE IN ITALY

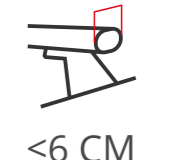
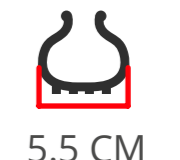
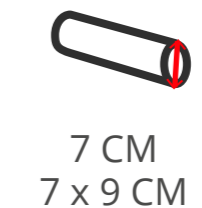

Per barre con cava a T art.364  
For bars with T section art.364

# Portabici Bike carriers

Portabici da tetto / Roof mounted bike carriers

## TOP BIKE - 314



# Caratteristiche Features

City✓Crash

100% MADE IN ITALY  
**Petuzzo**

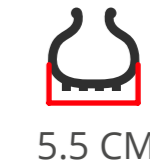

Per barre con cava a T art.364  
For bars with T section art.364





**“Le salite hanno strade strette e conducono là dove la vita è beata e un po’ incredula.”**

The climbs have narrow roads and lead where life is blissful and a little incredulous

**(G. FAVETTO)**





# Portabici Bike carriers

Portabici da tetto / Roof mounted bike carriers

## MODENA - 318



MIGLIOR PREZZO TRA I PRODOTTI DA TETTO SENZA  
CHIUSURA A CHIAVE  
Great value for money non lockable bike carrier

BINARIO DIVISO IN 2 PEZZI PER OTTIMIZZARE I COSTI  
DI TRASPORTO E LOGISTICA  
2 piece V tray for easy transport and storage

# Caratteristiche Features

City✓Crash

Petuzzo 100% MADE IN ITALY



MATERIALE/MATERIAL  
Acciaio/Steel



NR  
1

125 CM

7 CM  
7 x 9 CM

5.5 CM

<29"

TOT = 15 KG

137 x 20 x 9 CM

<6 CM

Per barre con cava a T art.364  
For bars with T section art.364



# Portabici Bike carriers

Portabici da tetto / Roof mounted bike carriers

## UNI BIKE - 320



**SISTEMA DI FISSAGGIO UNIVERSALE A PEDIVELLA**  
Universal clamp fixing system for pedal

**BINARIO DIVISO IN 2 PEZZI PER OTTIMIZZARE I COSTI DI TRASPORTO E LOGISTICA**  
2 piece V tray for easy transport and storage

# Caratteristiche Features

**Petuzzo**  
100% MADE IN ITALY



**MATERIALE/MATERIAL**  
Acciaio/Steel

**NR**   
1

  
125 CM

  
TUTTE  
ALL

  
5.5 CM

  
<29"

  
TOT = 15 KG

  
140 x 20 x 9 CM

  
<6 CM

Per barre con cava a T art.364  
For bars with T section art.364



# Portabici Bike carriers

Portabici da tetto / Roof mounted bike carrier

## LUCKY TWO - 317



**PORTABICI DA TETTO PIU' ECONOMICO**  
Entry value roof bike carrier

**BINARIO DIVISO IN 2 PEZZI PER OTTIMIZZARE I COSTI DI TRASPORTO E LOGISTICA**  
2 piece V tray for easy transport and storage

# Caratteristiche Features

**Petuzzo**  
100% MADE IN ITALY

**MATERIALE/MATERIAL**  
Acciaio/Steel



**NR**   
1

  
125 CM

  
5 CM

  
5.5 CM

  
<29"

  
TOT = 15 KG

  
137 x 20 x 9 CM

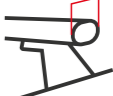
  
<6 CM

Per barre con cava a T art.364  
For bars with T section art.364





**“Il piacere della bicicletta è quello stesso della libertà”**

The pleasure of cycling is that of freedom

(A. ORIANI)



# Portabici Bike carriers

Portabici da tetto / Roof mounted bike carriers

## PURE INSTINCT ROOF FORK - 711



**COMPATIBILE CON FRENI A DISCO**  
Disk brake bikes friendly

**CINGHIE BLOCCA RUOTA CON CRICCHETTO E PROTEZIONE IN GOMMA**  
Wheel straps with ratchet and rubber protection

**CHIUSURA A CHIAVE SIA PER LA BICI CHE PER IL PRODOTTO SULLE BARRE PORTATUTTO**  
Secure - locks bike to carrier and carrier to roof bars

**KIT FISSAGGIO CAVA A T INCLUSO**  
T section fixing kit included

**DOTATO DI ADATTATORE CON PERNO PASSANTE D.9 MM**  
Adaptor for thru axle d.9 mm included

**Petuzzo**  
100% MADE IN ITALY

# Caratteristiche Features

City **V** Crash



**MATERIALE/MATERIAL**  
Alluminio/Aluminum



**NR**   
1

  
125 CM

  
TUTTE  
ALL

  
7 CM

  
<29"

  
TOT = 17 KG

  
140 x 22 x 10 CM

  
<8 CM

Per barre senza cava a T art.859  
For bars without T section art.859



# Portabici Bike carriers

Portabici da tetto / Roof mounted bike carriers

## PORDOI DELUX - 703



**POGGIARUOTA POSTERIORE REGOLABILE**  
Adjustable back wheel holder

**COMPATIBILE CON FRENI A DISCO**  
Disk brake bikes friendly

**PER BICI CON PERNO PASSANTE ART.407**  
For bikes with thru axle art.407

# Caratteristiche Features

City✓Crash

**Petuzzo**  
100% MADE IN ITALY



**MATERIALE/MATERIAL**  
Alluminio/Aluminum



**NR**   
1

  
120 CM

  
TUTTE  
ALL

  
6.5 CM

  
<29"

  
TOT = 15 KG

  
126 x 11 x 5 CM

  
<7 CM



**“Niente è paragonabile al semplice piacere di un giro in bicicletta”**

Nothing compares to the simple pleasure of a bicycle ride

(J. F. KENNEDY)



# Portabici Bike carriers

Portabici da tetto / Roof mounted bike carriers

## PORDOI - 702



**PRIMO PREZZO PER PRODOTTI A FORCELLA IN ALLUMINIO**  
Value carrier in aluminum range with fork fixing

**PER BICI CON PERNO PASSANTE ART.407**  
For bikes with thru axle art.407

**COMPATIBILE CON FRENI A DISCO**  
Disk brake bikes friendly



# Caratteristiche Features

City  Crash

**Petuzzo**  
100% MADE IN ITALY



**MATERIALE/MATERIAL**  
Alluminio/Aluminum

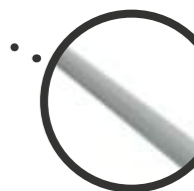

**NR**   
1



**VERIFICARE POSIZIONAMENTO  
BARRE PORTATUTTO**  
Verify carry bars placement



**TUTTE  
ALL**



6.5 CM



TOT = 15 KG



28 x 11 x 5 CM



<7 CM





# Portabici Bike carriers

Portabici da tetto / Roof mounted bike carriers

## ROLLE - 701



**IDEALE PER BICI DA CORSA**  
Ideal for racing bikes

**PER BICI CON PERNO PASSANTE ART.407**  
For bikes with thru axle art.407



**COMPATIBILE CON FRENI A DISCO**  
Disk brake bikes friendly

# Caratteristiche Features



**MATERIALE/MATERIAL**  
Plastica/Plastic



1

**VERIFICARE POSIZIONAMENTO  
BARRE PORTATUTTO**  
Verify carry bars placement



TOT = 15 KG



TUTTE  
ALL



5.5 CM



21 x 11 x 5 CM

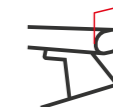

<7 CM



# Portabici Bike carriers

Portabici da tetto / Roof mounted bike carriers

## TOUR PROFESSIONAL - 309



MIGLIOR PREZZO TRA I PRODOTTI CON ATTACCO A FORCELLA  
Entry price product with fork fixing system



# Caratteristiche Features

**Petuzzo**  
100% MADE IN ITALY



MATERIALE/MATERIAL  
Plastica/Plastic

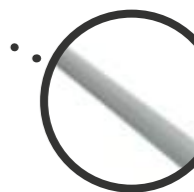

NR



1

VERIFICARE POSIZIONAMENTO  
BARRE PORTATUTTO  
Verify carry bars placement



TUTTE  
ALL

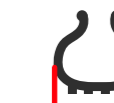

5.5 CM



TOT = 15 KG



21 x 11 x 5 CM



<7 CM



**Peruzzo** 100% MADE IN ITALY

# Portabici posteriore Rear bike carriers

Vivere in movimento *Life in motion*

# Portabici Bike carriers

## Portabici posteriore / Rear bike carriers

**PURE INSTINCT - 709**  
(2 BICI / 2 BIKES)



**COMPLETAMENTE ASSEMBLATO**  
● Fully assembled

**INTERASSE MAGGIORATO**  
● **TRA I BINARI (25 CM)**  
Increased spacing between rails (25 cm)

**ADATTO PER BICI DA 29" E FAT BIKES**  
Suitable for 29" bikes and fat bikes

**BINARI PIEGHEVOLI**  
● Foldable rails

# Caratteristiche Features

**Peruzzo**  
100% MADE IN ITALY



**MATERIALE/MATERIAL**  
Acciaio/Steel



**NR**   
2

  
120 CM

  
10 CM

  
12" - 29"

  
TOT = 45 KG

  
82 x 36 x 61 CM  
(chiuso/closed)  
82 x 90 x 98 CM  
(aperto/open)

 **EBIKE**  

**FAT**  

Ricerca adattabilità costantemente aggiornata a disposizione su [www.peruzzosrl.com](http://www.peruzzosrl.com)  
For up to date vehicle fitment compatibility please see website [www.peruzzosrl.com](http://www.peruzzosrl.com)



# Portabici Bike carriers

## Portabici posteriore / Rear bike carriers

**PURE INSTINCT - 709/3**  
(3 BICI / 3 BIKES)



● **COMPLETAMENTE ASSEMBLATO**  
Fully assembled

● **ADATTO PER BICI DA 29" E FAT BIKES**  
Suitable for 29" bikes and fat bikes

● **BINARI PIEGHEVOLI**  
Foldable rails



# Caratteristiche Features



● **MATERIALE/MATERIAL**  
Acciaio/Steel

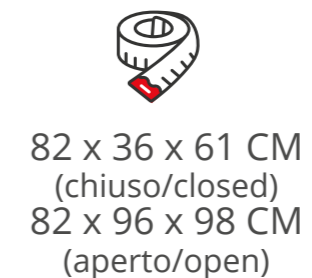



**“Pedala senza pensare a nient’altro che alla strada che percorri”**

Pedal without thinking of anything other than the road you are on

(C. DOYLE)



# Portabici Bike carriers

Portabici posteriore / Rear bike carriers

**FIRENZE - 660**  
**(2 BICI / 2 BIKES)**



● **ATTACCO RAPIDO SUPERIORE**  
Rigid top fixing brackets

● **CINGHIE BLOCCA RUOTA CON CRICCHETTO**  
Wheel straps with ratchets

● **COMPATTO**  
Folds flat for space saving storage

# Caratteristiche Features

**Peruzzo**  
100% MADE IN ITALY



● **MATERIALE/MATERIAL**  
Alluminio/Aluminum

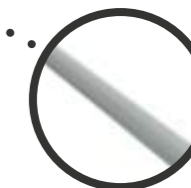

**NR**   
2

  
115 CM

  
7 CM

  
<29"

  
TOT = 30 KG

  
72 x 70 x 90 CM



# Portabici Bike carriers

## Portabici posteriore / Rear bike carriers

**FIRENZE - 660/3**  
(3 BICI / 3 BIKES)



**ATTACCO RAPIDO SUPERIORE**  
Fixed top system with brackets

**COMPATTO**  
Folds flat for space saving

**CINGHIE BLOCCA RUOTA CON CRICCHETTO**  
Wheel straps with ratchets

# Caratteristiche Features

**Peruzzo**  
100% MADE IN ITALY



**MATERIALE/MATERIAL**  
Alluminio/Aluminum

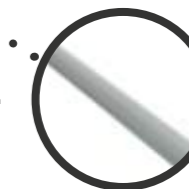

**NR**  
3

115 CM

7 CM

<29"

TOT = 45 KG

72 x 70 x 113 CM







**"Il paradiso in terra non esiste, ma chi va in bicicletta ci arriverà comunque"**

Heaven on earth does not exist, but those who ride a bicycle will get there anyway

(M. PARRINI)



# Portabici Bike carriers

Portabici posteriore / Rear bike carriers

**PADOVA ALU - 650**  
(2 BICI / 2 BIKES)



PRIMO PREZZO TRA I PRODOTTI IN ALLUMINIO CON BINARIO  
Value aluminum rear carrier with rails

PER BICI DA 29" DISPONIBILE ART.989  
For 29" bikes available accessory art.989

COMPLETAMENTE REGOLABILE E PRATICO  
Quick and easy to fit and remove



# Caratteristiche Features

**Peruzzo**  
100% MADE IN ITALY



MATERIALE/MATERIAL  
Alluminio/Aluminum



NR  
2

110 CM

6 CM

<28"

TOT = 30 KG

100 x 121 x 80 CM



# Portabici Bike carriers

Portabici posteriore / Rear bike carriers

**PADOVA ALU - 650/3**  
(3 BICI / 3 BIKES)



PRIMO PREZZO TRA I PRODOTTI IN ALLUMINIO CON BINARIO  
● Entry price for aluminium rear carriers with rails

PER BICI DA 29" DISPONIBILE  
ART.989  
● For 29" bikes available accessory art.989

COMPLETAMENTE REGOLABILE E PRATICO  
Quick and easy to fit and remove ●



# Caratteristiche Features

**Peruzzo**  
100% MADE IN ITALY



NR  
3

110 CM

6 CM

<28"

TOT = 45 KG

100 x 121 x 90 CM





**“Quella della bici è l’unica catena che ti rende libero”**

The bike chain is the only chain that will set you free

(V. DE FELICE)



# Portabici Bike carriers

Portabici posteriore / Rear bike carriers

**PADOVA STEEL - 378**  
(2 BICI / 2 BIKES)



**OTTIMO RAPPORTO QUALITA' - PREZZO**  
Good value for money

**ADATTO PER BICI DA 28"**  
Suitable for 28" bikes

**COMPLETAMENTE REGOLABILE E PRATICO**  
Quick and easy to fit and remove



# Caratteristiche Features

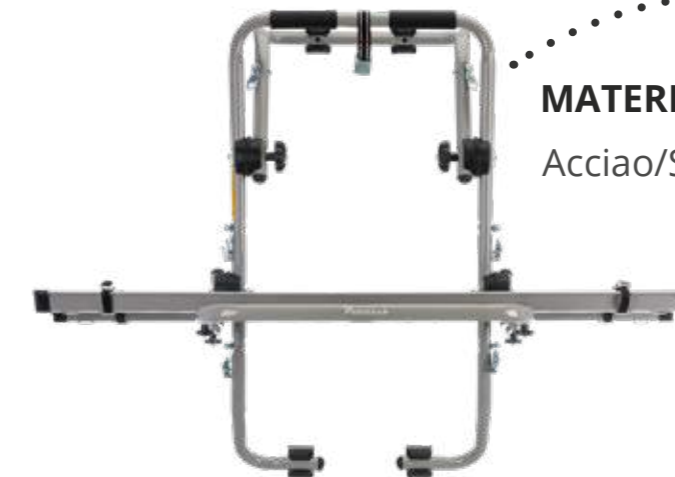

**MATERIALE/MATERIAL**  
Acciaio/Steel

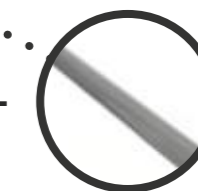

**NR**   
2

  
110 CM

  
7 CM

  
<28"

  
TOT = 30 KG

  
100 x 121 x 80 CM



# Portabici Bike carriers

Portabici posteriore / Rear bike carriers

**PADOVA STEEL - 378/3**  
(3 BICI / 3 BIKES)



● OTTIMO RAPPORTO QUALITA' - PREZZO  
Good value for money

● ADATTO PER BICI DA 28"  
Suitable for 28" bikes

● COMPLETAMENTE REGOLABILE E PRATICO  
Quick and easy to fit and remove



# Caratteristiche Features

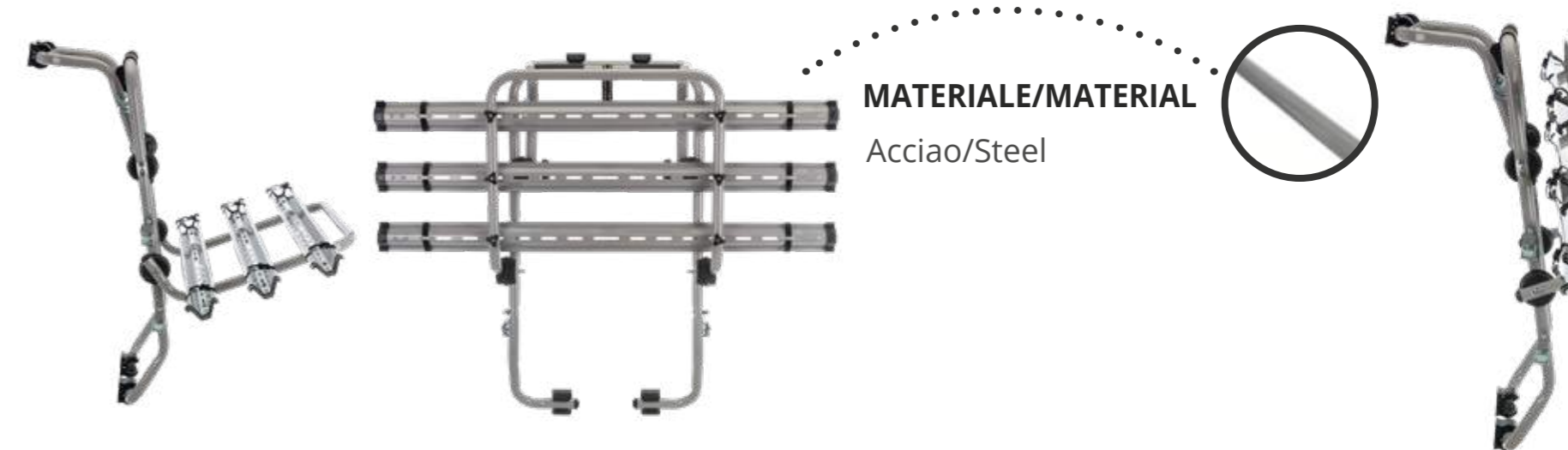

MATERIALE/MATERIAL  
Acciaio/Steel

NR   
3

  
110 CM

  
7 CM

  
<28"

  
TOT = 45 KG

  
100 x 121 x 90 CM



# Portabici Bike carriers

Portabici posteriore / Rear bike carriers

**MILANO - 620 / 625**  
**(3 BICI / 3 BIKES)**



# Caratteristiche Features

**Peruzzo** 100% MADE IN ITALY



## MATERIALE/MATERIAL

Alluminio/Aluminum art.620  
Acciaio/Steel art.625

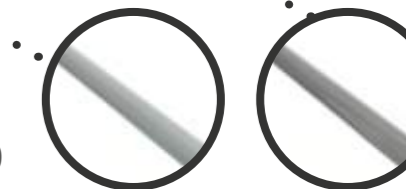



**“Un giro in bicicletta è una fuga dalla tristezza”**

A bike ride is an escape from sadness.

**(J. E. STARRS)**





# Portabici Bike carriers

## Portabici posteriore / Rear bike carriers

**VENEZIA - 388 / 388/A**  
**(3 BICI / 3 BIKES)**

	SCATOLA/BOX	TERMORETRAIBILE/SHRINK WRAP
Alluminio/Aluminum	art.388 ASC	art.388/A
Acciaio/Steel	art.388SC	art.388

**SISTEMA BLOCCABICI CON PROTEZIONE AD EFFETTO AMMORTIZZATORE**  
Schock absorbing frame support

**BRACCIA RICHIUDIBILI**  
Folds flat for storage

**COMPLETAMENTE ASSEMBLATO**  
Fully assembled

**IDEALE PER AUTO CON SPOILER**  
Ideal for cars with spoiler

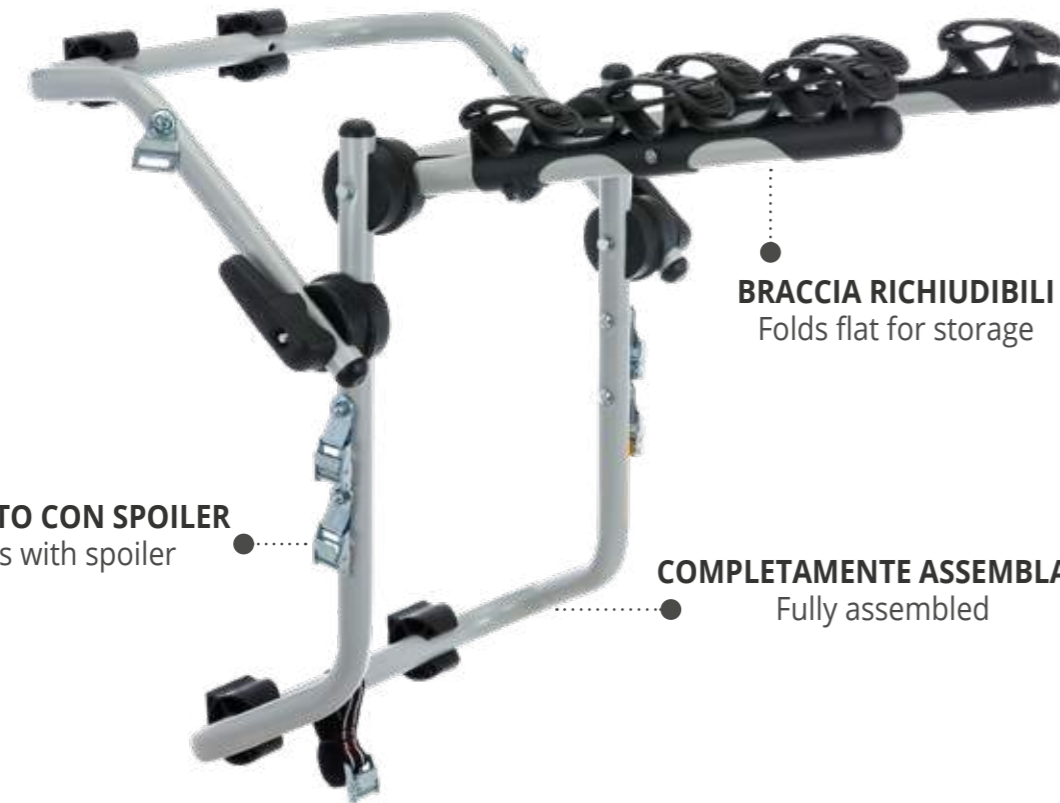

# Caratteristiche Features

**Peruzzo**  
100% MADE IN ITALY

**MATERIALE/MATERIAL**

Alluminio/Aluminum  
Acciaio/Steel

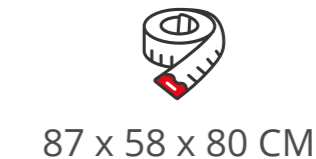

# Portabici Bike carriers

Portabici posteriore / Rear bike carriers

**VERONA - 382 / 382/A**  
(3 BICI / 3 BIKES)

SCATOLA/BOX		TERMORETRAIBILE/SHRINK WRAP
Alluminio/Aluminum	art.382/ASC	art.382/A
Acciaio/Steel	art.382SC	art.382



**SISTEMA BLOCCABICI CON PROTEZIONE AD EFFETTO AMMORTIZZATORE**  
Shock absorbing frame support

**BRACCIA RICHIUDIBILI**  
Folds flat for storage

**COMPLETAMENTE ASSEMBLATO**  
Fully assembled

# Caratteristiche Features



**MATERIALE/MATERIAL**  
Alluminio/Aluminum  
Acciaio/Steel

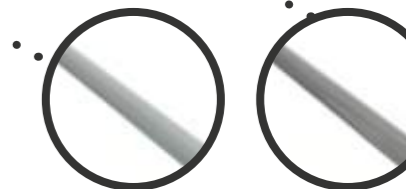

**NR**   
3

  
MIN 33 CM

  
< 6 CM

  
TUTTE  
ALL

  
TUTTE  
ALL

   
TOT = 45 KG

  
77 x 58 x 53 CM



# Portabici Bike carriers

## Portabici posteriore / Rear bike carriers

### BASSANO DEL GRAPPA - 381 (1 BICI / 1 BIKE)



# Caratteristiche Features



**MATERIALE/MATERIAL**  
Acciaio/Steel

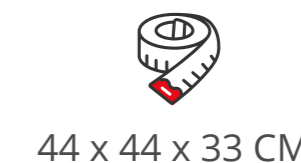
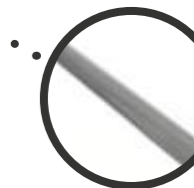



**"Solo in bicicletta puoi sorprendere le cose senza essere visto, come sanno fare i poeti"**

Only whilst cycling can you surprise without being seen, as poets know how to do

**(A. D'AVENIA)**



# Portabici Bike carriers

## Portabici posteriore / Rear bike carriers

### NEW HI-BIKE - 308 (3 BICI / 3 BIKES)

**REGOLABILE**  
Easy to fit and remove

**PRATICO E COMPATTO**  
Simple to use

**SISTEMA BLOCCABICI CON PROTEZIONE AD EFFETTO  
AMMORTIZZATORE**  
Shock absorbing frame support

**PARTICOLARMENTE ADATTO PER MODELLI BERLINA**  
Particularly suitable for sedan models

# Caratteristiche Features

**Peruzzo**  
100% MADE IN ITALY



**MATERIALE/MATERIAL**  
Acciaio/Steel



# Portabici Bike carriers

Portabici posteriore / Rear bike carriers

**CRUISER DELUX - 324 / 352**  
(3 BICI / 3 BIKES)

SCATOLA/BOX

art.324

TERMORETRAIBILE/SHRINK WRAP

art.352

**PRATICO E COMPATTO**  
Easy to use



**SISTEMA BLOCCABICI CON PROTEZIONE AD EFFETTO AMMORTIZZATORE**  
Shock absorbing frame support

**BRACCIA RICHIUDIBILI**  
Folds flat for storage

# Caratteristiche Features

**Peruzzo**  
100% MADE IN ITALY



**MATERIALE/MATERIAL**

Acciaio/Steel



**NR**   
3

  
MIN 41.5 CM

  
< 6 CM

  
TUTTE  
ALL

  
TUTTE  
ALL

  
TOT = 45 KG

  
70 x 47 x 58 CM



# Portabici Bike carriers

## Portabici posteriore / Rear bike carriers

**NEW CRUISER - 305 / 306**  
(3 BICI / 3 BIKES)

SCATOLA/BOX

art.305

TERMORETRAIBILE/SHRINK WRAP

art.306



**BRACCIA RICHIUDIBILI**  
Folds flat for storage

**PRATICO E COMPATTO**  
Easy to use



# Caratteristiche Features



**MATERIALE/MATERIAL**  
Acciaio/Steel

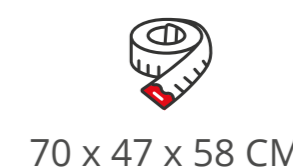

Ricerca adattabilità costantemente aggiornata a disposizione su [www.peruzzosrl.com](http://www.peruzzosrl.com)  
For up to date vehicle fitment compatibility please see website [www.peruzzosrl.com](http://www.peruzzosrl.com)



# Portabici Bike carriers

## Portabici posteriore / Rear bike carriers

**GENOVA - 651**  
(2/4 BICI / 2/4 BIKES)



**PUO' ESSERE EQUIPAGGIATO FINO A 4 POSTAZIONI**  
Can be supplied up to 4 bike holders on request

**UNIVERSALE CON ATTACCO A FORCELLA**

.....● Universal, with fork fixing

**PORTABICI DA INTERNO AUTO  
O DA CASSONE O PICK UP**

.....● Bike carrier for use inside  
people carriers, vans, pickups  
etc..

**Peruzzo**  
100% MADE IN ITALY

# Caratteristiche Features



**MATERIALE/MATERIAL**

Alluminio/Aluminum



2 - 4



TUTTE  
ALL



TUTTE  
ALL



TUTTE  
ALL



TUTTE  
ALL



TOT = 45 KG



70 x 47 x 58 CM





**Peruzzo**  
100% MADE IN ITALY

# Portabici 4x4 4x4 bike carriers

Vivere in movimento *Life in motion*



# Portabici Bike carriers

## Portabici 4x4 / 4x4 bike carriers

### STELVIO ALU - 373/A + 375/A (2 BICI / 2 BIKES)



**COMPATIBILE CON L'ACCESSORIO PORTASCI/SNOWBOARD**

● Compatible with accessory ski/snowboard carrier

**FISSAGGIO ALLA RUOTA TRAMITE APPOSITA PIASTRA**

● Easy wheel fixing to with only one bolt to support panel

**PER BICI DA 29" DISPONIBILE ART.989**

● For 29" bikes available accessory art.989

**POSSIBILITA' DI SPOSTARE I BINARI IN BASE ALLA POSIZIONE DELLA RUOTA**  
Possibility to move and place the rails to match the corresponding position of the bike wheels

# Caratteristiche Features

ART.375/A



ART.373/A

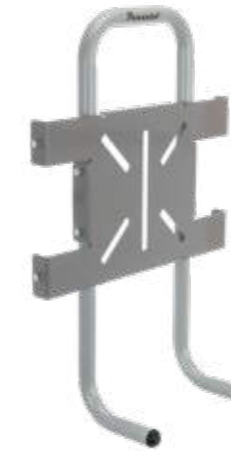

ART.376/A



**MATERIALE/MATERIAL**

Alluminio/Aluminum



2



110 CM



6 CM



28"



TOT = 30 KG



87 x 121 X 53 CM



4



2



# Portabici Bike carriers

## Portabici 4x4 / 4x4 bike carriers

### STELVIO STEEL - 373 + 375 (2 BICI / 2 BIKES)



**COMPATIBILE CON L'ACCESSORIO PORTASCI/SNOWBOARD**

● Suitable with accessory ski/snowboard carrier

**FISSAGGIO ALLA RUOTA TRAMITE APPOSITA PIASTRA**

● Easy to fit with only one bolt

**POSSIBILITA' DI SPOSTARE I BINARI IN BASE ALLA POSIZIONE DELLA RUOTA**  
Possibility to move and place the rails to match the corresponding position of the wheel

## Caratteristiche Features



**MATERIALE/MATERIAL**

Acciaio/Steel

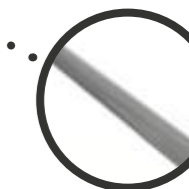

2



110 CM



7 CM



28"



TOT = 30 KG



87 x 121 X 53 CM



4



2





**“Il mondo è un libro, e quelli che non viaggiano ne leggono solo una pagina”**

**The world is a book, and those who don't travel read only one page**

**(A. D'IPPONA)**



# Portabici Bike carriers

## Portabici 4x4 / 4x4 bike carriers

**BRENNERO - 313**  
(2 BICI / 2 BIKES)



**FISSAGGIO ALLA RUOTA TRAMITE CINGHIE**  
Easy to fit with straps

**POSSIBILITA' DI SPOSTARE I BINARI IN BASE ALLA POSIZIONE DELLA RUOTA**  
Possibility to move and place the rails to match the corresponding position of the bike wheels



# Caratteristiche Features



**MATERIALE/MATERIAL**  
Acciaio/Steel

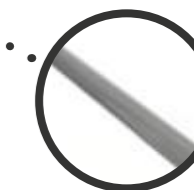

**NR**   
2

  
110 CM

  
7 CM

  
28"

  
TOT = 30 KG

  
87 x 121 X 53 CM



# Portabici Bike carriers

Portabici 4x4 / 4x4 bike carriers

**4 x 4 BIKE CARRIER - 310 / 387**  
(2 BICI / 2 BIKES)



DISPONIBILE CON TUBO DIAM 25 MM (art.310)  
O DIAM 30 MM (art.387)  
Available with tube diam 25 mm (art.310)  
or diam 30 mm (art.387)

ADATTO A TUTTI I TIPI DI BICICLETTE  
Universal fit for all types of bicycles

# Caratteristiche Features

**Petuzzo**  
100% MADE IN ITALY



**NR**  
2

MIN 38 CM

< 6 CM

TUTTE  
ALL

TUTTE  
ALL

TOT =30 KG

86 x 85 x 58 CM



+ more space for your journeys  
*più spazio ai vostri viaggi*



Via S. Allende, 15 - 42020 Quattro Castella (RE) Italy  
[www.g3spa.it](http://www.g3spa.it)



## Un pò di noi...

Qualità, serietà e ricerca sono alcuni dei valori guida sui quali G3 poggia le proprie basi fin dal 1973. Abbiamo sviluppato anche altri valori che oggi sono prepotentemente entrati a far parte del "DNA" dell'intera organizzazione; uno di questi è sicuramente il rispetto per l'ambiente e attenzione per i nostri lavoratori, al fine di assicurare un Know-how sempre stimolante.

L'obiettivo è quindi quello di crescere in molte direzioni, con l'idea di poter migliorare i risultati raggiunti e rendere l'automobile sempre più vicina alle vostre esigenze.



## Something about us...

Quality, seriousness and research are some of the guiding values on which G3 has been building its foundation since 1973. We've also developed other values, which have nowadays forcefully become part of the "DNA" of the entire organization; one of these is certainly the respect for the environment and the attention to our workers, in order to ensure an always stimulating know-how.

The goal is therefore to grow up in many directions, with the idea of improving the achieved results and make the car closer and closer to your needs.





# La nostra azienda

## Our company

Le origini artigianali continuano a respirarsi nell'azienda, ma G3 negli anni ha dovuto munirsi anche di processi di ricerca e sviluppo all'altezza dei clienti di livello mondiale che è stata capace di attirare a sé.

You can still feel the artisan origins in the company, however throughout the years G3 also had to obtain research and development processes worthy of the world-class customers the company has been able to attract.





**Fornitore ufficiale Official supplier**

**Box da tetto Roof boxes**

**Barre porta tutto Roof bars**



# Fornitore ufficiale Official supplier



Ricerca delle linee migliori, cura del dettaglio, costanti investimenti nello studio dei materiali sono le direzioni in cui l'organizzazione si dirige, mantenendo alto l'interesse di offrire ai propri clienti prodotti all'avanguardia, senza mai trascurare il gusto estetico ed il design tipicamente italiani.

Fiat, Alfa Romeo, Lancia, Maserati, Audi, Volkswagen, Lamborghini, Seat, Skoda, Kia, Hyundai, Ford, Mitsubishi, Nissan, Opel, Peugeot, Citroen, Dacia e Renault hanno scelto di collaborare con G3 S.p.a.

The search for better lines, the care for details and the continuous investments in the research of the raw materials are the directions of the organisation, maintaining a high interest in offering avant-garde products, without neglecting the typical Italian style and design.

Fiat, Alfa Romeo, Lancia, Maserati, Audi, Volkswagen, Lamborghini, Seat, Skoda, Kia, Hyundai, Ford, Mitsubishi, Nissan, Opel, Peugeot, Citroen, Dacia and Renault chose to cooperate with G3 S.p.a.

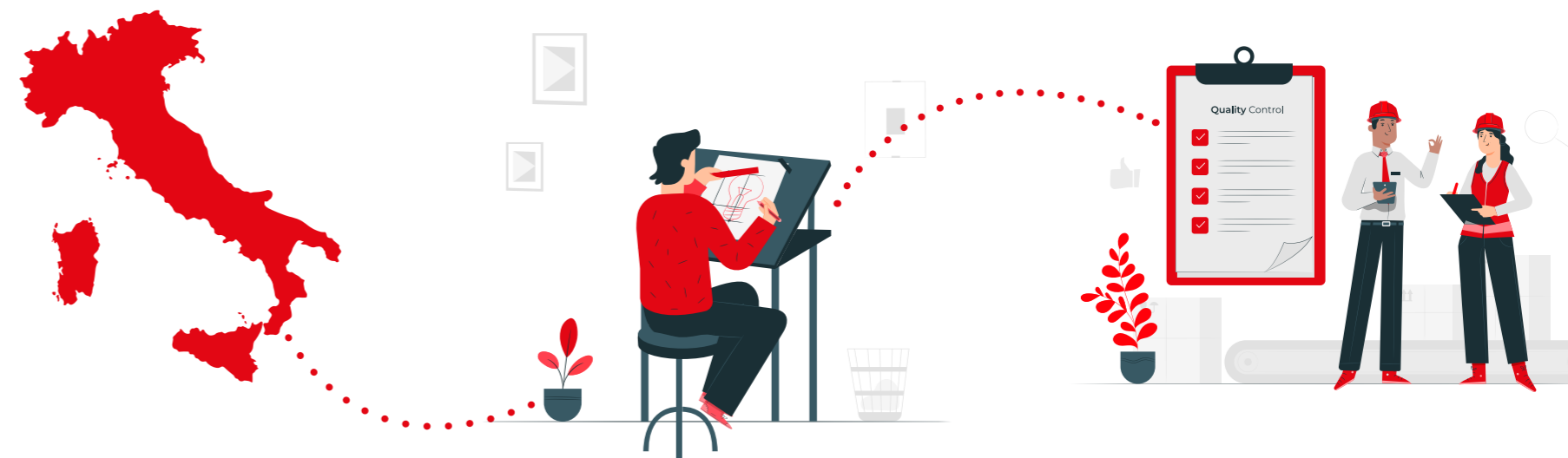

## Massima flessibilità

Il nostro obiettivo è essere in grado di guidare il processo e seguire le richieste: vogliamo soddisfare le richieste del mercato.

## Gestione della qualità

Il sito produttivo e i processi sottostanno alla normativa ISO 9001:2015 e IATF 16949:2016.

## Progettazione su misura

Siamo in grado di seguire tutto il processo legato ad un prodotto, dall'idea alla produzione, raggiungendo la miglior soluzione in termini di adattabilità.

## Produzione interna

Tutti i nostri prodotti sono orgogliosamente realizzati al 100% in Italia per dare soluzioni su scala globale.

## Maximum Flexibility

Our aim is to be able to lead the process and to follow your request: we want to meet your needs.

## Quality Management

Production site and processes are certified ISO 9001:2015 and IATF 16949:2016.

## Specific Engineering

We follow all the processes, from the concept to the production, to reach the best fitting solution.

## Domestic Production

Our products are proudly 100% made in Italy in order to give worldwide solutions.

**GS**



# Box da tetto Roof boxes

Più spazio ai vostri viaggi *More space for your journeys*



## I nostri box Our boxes



> *bicube*

Da pag. 172 a pag.175



> *spark*

Da pag. 178 a pag. 185



> *spark.eco*

Da pag. 188 a pag. 192



> *absolute*

Da pag. 194 a pag. 197



> *all-time*

Da pag. 200 a pag. 203



> *reef*

Da pag. 206 a pag. 210



> *helios*

Da pag. 212 a pag. 217



> *krono*

Da pag. 220 a pag. 224



> *arjes*

Da pag. 226 a pag. 229



> *hydra*

Da pag. 232 a pag. 235



> *pegaso*

Da pag. 238 a pag. 240



> *sirio*

Da pag. 242 a pag. 244



> *cargo*

Da pag. 246 a pag. 249



# La nostra qualità Our quality



## CITY CRASH

Tutta la gamma prodotti G3 ha brillantemente superato i test ISO/PAS. Testati con una forza di impatto pari a 8G ed un peso che varia dai 50 kg ai 75 kg.

## CITY CRASH

G3 complete range has successfully passed the ISO/PAS tests. All roofboxes are tested with an impact force equal to 8G and a weight range between 50 kg and 75 kg.



## EASY-SYSTEM

Efficiente sistema di montaggio rapido (tempo non superiore a 15 min.) ottenuto grazie al lavoro di pre-montaggio ed alla cura per i dettagli che G3 mette in tutti i suoi prodotti.

## EASY-SYSTEM

Efficient rapid assembly time (no longer than 15 min.) achieved thanks to a pre-assembly work and G3 attention to details.



## UV

Il materiale subisce un trattamento di schermatura per proteggere il prodotto dai raggi UV e mantenerlo integro nel tempo.

## UV

Shielding treatment of the material protects the product from Ultraviolets (uv rays) in order to last over time.



## SISTEMA DI APERTURA DUAL SIDE

Il sistema di apertura Dual Side permette di aprire il box da entrambi i lati per agevolarne montaggio, carico e scarico.

## DUAL SIDE OPENING SYSTEM

The Dual Side opening system allows you to open the box from both sides to facilitate assembly, loading and unloading.

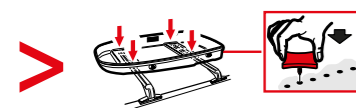

## PREFORATURA

Grazie al sistema di preforatura G3 sarà sufficiente l'utilizzo del pratico Hole Maker Tool (fornito in dotazione con ogni box) per facilitare la fase di montaggio.

## PRE-DRILLED HOLES

Thanks to G3 pre-drilling system, the use of the practical Hole Maker Tool (supplied with each box) will help you with the assembly phase.

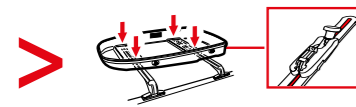

## AGGANCIO SCORREVOLE "RAPID"

Grazie al nuovo sistema di Aggancio Rapido G3, l'installazione del box sarà ancora più facile e veloce.

## "RAPID" SLIDING HOOK

Thanks to the new G3 Quick Coupling system, the installation of the box will be even easier and faster.



## EASYFIX

Montaggio rapido del prodotto ottenuto senza bisogno di attrezzi aggiuntivi.

## EASYFIX

Easy and fast assembling of the product without the use of any additional tool.



## MATERIALE

PS = Polistirolo.

## MATERIALE

PS = Polystyrene.



## MATERIALE

ABS = Acrilonitrile Butadiene Stirene.

## MATERIALE

ABS = Acrylonitrile Butadiene Styrene.

## TABELLA COMPARATIVA

Abbiamo confrontato le diverse taglie dei nostri box per darti la possibilità di capire quale prodotto si abbina meglio al tuo segmento di auto.

## COMPARATIVE CHART

We have compared the different sizes of our boxes to give you the opportunity to understand which product best matches your car segment.

	CITY CAR	COMPATTA	BERLINA	SW	SUV
<b>S</b> 1180/1338 mm					
<b>M</b> 1440/1520mm					
<b>L</b> 1776/1985 mm					
<b>XL</b> 2200/2280 mm					

soluzione OTTIMALE | BEST solution

soluzione POSSIBILE | POSSIBLE solution

# Box da tetto Roof boxes

Garantee  
3  
years

PS  
MATERIAL

UV  
11

EASYFIX

CityCrash



> **bicube 400+**

# Caratteristiche Features



**MAXI CAPIENZA**  
Maxi capacity



**APERTURA/OPENING**

Dual Side



**CODICE/CODE**

22.604  
8010682050462 (EAN)



**FISSAGGIO/FIXING KIT**

K9.009



**CARICO MAX./MAX LOAD**

75 Kg



**CAPACITA'/CAPACITY**

400+  
360 lt (effettiva/real)



**SERRATURA/LOCK**

2 centralizzate/centralized  
(K3.013)



**MISURE/MEASURES**

1456 x 850 x 436 mm  
1366 x 750 x 426 mm (interne/internal)



**COMPASSO/SPRING JACK**

Front: K3.014  
Rear: K3.014

# Box da tetto Roof boxes

Guarantee  
3 years

PS  
MATERIAL

UV

EASYFIX

CityCrash

• nero opaco - matt black •



> **bicube 400+ disassembled**

# Caratteristiche Features



**SMONTABILE**  
Dismountable

35%

**SALVASPAZIO**  
Space-saving



**APERTURA/OPENING**

Dual Side



**CODICE/CODE**

22.654  
8010682050479 (EAN)



**FISSAGGIO/FIXING KIT**

K9.009



**CARICO MAX./MAX LOAD**

75 Kg



**CAPACITA'/CAPACITY**

400+  
360 lt (effettiva/real)



**SERRATURA/LOCK**

2 centralizzate/centralized  
(K3.013)



**MISURE/MEASURES**

1456 x 850 x 280 mm  
1366 x 750 x 270 mm (interne/internal)



**COMPASSO/SPRING JACK**

Front: K3.014  
Rear: K3.014



An aerial, black and white photograph of a wooden pier extending into a body of water. Several small, narrow boats are docked along the pier. In the foreground, a car is parked on the pier with two bicycles secured to its roof rack. A tall, thin pole with a light fixture stands on the pier. The water is calm with subtle ripples. The overall scene is quiet and somewhat desolate.

**" I rettilinei sono soltanto i tratti noiosi che collegano le curve"**

The straights are just the boring stretches that connect the curves

(S.MOSS)

# Box da tetto Roof boxes

Guarantee  
5 years

PS  
MATERIAL

ABS  
MATERIAL

UV  
PROTECTION

EASYFIX

CityCrash



> **spark**

# Caratteristiche Features

*spark 320*



**APERTURA/OPENING**  
Right Side



**CODICE/CODE**

22.400  
8010682039382 (EAN)



**FISSAGGIO/FIXING KIT**

K9.042



**CARICO MAX./MAX LOAD**

50 Kg



**CAPACITA'/CAPACITY**

320  
240 lt (effettiva/real)



**SERRATURA/LOCK**

1 pulsante/1 push button  
(K3.003)



**MISURE/MEASURES**

1338 x 730 x 360 mm  
1248 x 670 x 350 mm (interne/internal)



**COMPASSO/SPRING JACK**

Front K3.014  
Rear: K3.014



## Caratteristiche Features

### spark 400



**APERTURA/OPENING**  
Dual Side



**CODICE/CODE**  
22.404  
8010682046588 (EAN)



**FISSAGGIO/FIXING KIT**  
K9.042



**CARICO MAX./MAX LOAD**  
75 Kg



**CAPACITA'/CAPACITY**  
400  
330 lt (effettiva/real)



**SERRATURA/LOCK**  
2 centralizzate/centralized  
(K3.013)



**MISURE/MEASURES**  
1440 x 860 x 375 mm  
1350 x 760 x 365 mm (interne/internal)



**COMPASSO/SPRING JACK**  
Front: K3.014  
Rear: K3.014



## Caratteristiche Features

### spark 420



**SUPER SOTTILE**  
Super Slim



**APERTURA/OPENING**  
Dual Side



**CODICE/CODE**  
22.405  
8010682038491(EAN)



**FISSAGGIO/FIXING KIT**  
K9.042



**CARICO MAX./MAX LOAD**  
75Kg



**CAPACITA'/CAPACITY**  
420  
370 lt (effettiva/real)



**SERRATURA/LOCK**  
2 centralizzate/centralized  
(K3.013)



**MISURE/MEASURES**  
1928 x 550 x 492 mm  
1838 x 450 x 482 mm (interne/internal)



**COMPASSO/SPRING JACK**  
Front: K3.014  
Rear: K3.014



## Caratteristiche Features

### spark 480



**APERTURA/OPENING**  
Dual Side



**CODICE/CODE**  
22.407  
8010682046601 (EAN)



**FISSAGGIO/FIXING KIT**  
K9.042



**CARICO MAX./MAX LOAD**  
75 Kg



**CAPACITA'/CAPACITY**  
480 lt  
390 lt (effettiva/real)



**SERRATURA/LOCK**  
2 centralizzate/centralized  
(K3.013)



**MISURE/MEASURES**  
1950 x 738 x 360 mm  
1860 x 638 x 350 mm (interne/internal)



**COMPASSO/SPRING JACK**  
Front: K3.014  
Rear: K3.014



## Caratteristiche Features

### spark 520



**IL PRESELTO**  
The Chosen One



**APERTURA/OPENING**  
Dual Side



**CODICE/CODE**  
22.406  
8010682044591(EAN)



**FISSAGGIO/FIXING KIT**  
K9.042



**CARICO MAX./MAX LOAD**  
75Kg



**CAPACITA'/CAPACITY**  
520  
420 lt (effettiva/real)



**SERRATURA/LOCK**  
2 centralizzate/centralized  
(K3.013)



**MISURE/MEASURES**  
1776 x 938 x 379 mm  
1686 x 838 x 369 mm (interne/internal)



**COMPASSO/SPRING JACK**  
Front: K3.014  
Rear: K3.014



ABS  
Acrylonitrile Butadiene Styrene



## Caratteristiche Features

*spark 520 bianco*



**APERTURA/OPENING**  
Dual Side



**CODICE/CODE**

22.446  
8010682049091 (EAN)



**FISSAGGIO/FIXING KIT**

K9.042



**CARICO MAX./MAX LOAD**

75 Kg



**CAPACITA'/CAPACITY**

520  
420 lt (effettiva/real)



**SERRATURA/LOCK**

2 centralizzate/centralized  
(K3.013)



**MISURE/MEASURES**

1776 x 938 x 379 mm  
1686 x 838 x 369 mm (interne/internal)



**COMPASSO/SPRING JACK**

Front: K3.014  
Rear: K3.014



**FISSAGGIO ULTRA VELOCE**  
Ultra Fast Fixing



## Caratteristiche Features

*spark.rapid 520*



**APERTURA/OPENING**  
Dual Side



**CODICE/CODE**

22.1406  
8010682052268 (EAN)



**FISSAGGIO/FIXING KIT**

K9.142



**CARICO MAX./MAX LOAD**

75Kg



**CAPACITA'/CAPACITY**

520  
420 lt (effettiva/real)



**SERRATURA/LOCK**

2 centralizzate/centralized  
(K3.013)



**MISURE/MEASURES**

1776 x 938 x 379 mm  
1686 x 838 x 369 mm (interne/internal)



**COMPASSO/SPRING JACK**

Front: K3.014  
Rear: K3.014



**“Quando l’uomo ha mete da raggiungere, non può invecchiare”**

When man has goals to achieve, he cannot grow old

**(E.FERRARI)**



# Box da tetto Roof boxes

Garantie  
3  
years

PS  
MATERIAL

UV  
17

EASYFIX

CityCrash

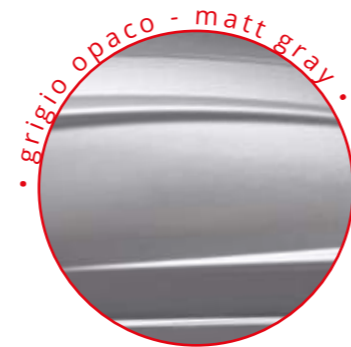

grigio opaco - matt gray



> **spark.eco**

# Caratteristiche Features

*spark.eco 320*



**APERTURA/OPENING**

Right Side



**CODICE/CODE**

22.410  
8010682046748 (EAN)



**FISSAGGIO/FIXING KIT**

K9.009



**CARICO MAX./MAX LOAD**

50 Kg



**CAPACITA'/CAPACITY**

320  
240 lt (effettiva/real)



**SERRATURA/LOCK**

1 pulsante/1 push button  
(K3.003)



**MISURE/MEASURES**

1338 x 730 x 360 mm  
1248 x 670 x 350 mm (interne/internal)



**COMPASSO/SPRING JACK**

Front: K3.011  
Rear: K3.010





## Caratteristiche Features

*spark.eco 400*



**APERTURA/OPENING**

Right Side



**CODICE/CODE**

22.414  
8010682046595 (EAN)



**FISSAGGIO/FIXING KIT**

K9.009



**CARICO MAX./MAX LOAD**

75 Kg



**CAPACITA'/CAPACITY**

400  
330 lt (effettiva/real)



## Caratteristiche Features

*spark.eco 480*



**APERTURA/OPENING**

Right Side



**CODICE/CODE**

22.417  
8010682046618 (EAN)



**FISSAGGIO/FIXING KIT**

K9.009



**CARICO MAX./MAX LOAD**

75Kg



**CAPACITA'/CAPACITY**

480  
390 lt (effettiva/real)



**SERRATURA/LOCK**

1 centralizzata/1 centralized  
(K3.013)



**MISURE/MEASURES**

1440 x 860 x 375 mm  
1350 x 800 x 365 mm (interne/internal)



**COMPASSO/SPRING JACK**

Front: K3.011  
Rear: K3.010



**SERRATURA/LOCK**

1 centralizzata/1 centralized  
(K3.013)



**MISURE/MEASURES**

1950 x 738 x 360 mm  
1860 x 678 x 350 mm (interne/internal)



**COMPASSO/SPRING JACK**

Front: K3.011  
Rear: K3.010







IL PRECELTO ECO  
The chosen one eco



## Caratteristiche Features

*spark.eco 520*



**APERTURA/OPENING**

Right Side



**CODICE/CODE**

22.416  
8010682046045 (EAN)



**FISSAGGIO/FIXING KIT**

K9.009



**CARICO MAX./MAX LOAD**

75 Kg



**CAPACITA'/CAPACITY**

520  
420 lt (effettiva/real)



**SERRATURA/LOCK**

1 centralizzata/1 centralized  
(K3.013)



**MISURE/MEASURES**

1776 x 938 x 379 mm  
1686 x 878 x 369 mm (interne/internal)



**COMPASSO/SPRING JACK**

Front: K3.010  
Rear: K3.010



**"Il motore non ragiona, il pilota si"**

The engine doesn't think, the pilot does

(N.LAUDA)

# Box da tetto Roof boxes

Guarantee  
5  
years

PS  
MATERIAL

UV  
11

EASYFIX

CityCrash

goffrato grigio - Embossed grey



> *absolute*

# Caratteristiche Features

*absolute 320*



**APERTURA/OPENING**

Right Side



**CODICE/CODE**

22.310  
8010682037937 (EAN)



**FISSAGGIO/FIXING KIT**

K9.009



**CARICO MAX./MAX LOAD**

50 Kg



**CAPACITA'/CAPACITY**

320  
240 lt (effettiva/real)



**SERRATURA/LOCK**

1 pulsante/1 push button  
(K3.003)



**MISURE/MEASURES**

1330 x 735 x 365 mm  
1240 x 675 x 355 mm (interne/internal)



**COMPASSO/SPRING JACK**

Front: K3.015  
Rear: K3.014



## Caratteristiche Features

### *absolute 400*



**APERTURA/OPENING**  
Dual Side



**CODICE/CODE**  
22.314  
8010682037944 (EAN)



**FISSAGGIO/FIXING KIT**  
K9.009



**CARICO MAX./MAX LOAD**  
75 Kg



**CAPACITA'/CAPACITY**  
400  
330 lt (effettiva/real)



**SERRATURA/LOCK**  
2 centralizzate/2 centralized  
(K3.013)



**MISURE/MEASURES**  
1462 x 867 x 375 mm  
1372 x 767 x 365 mm (interne/internal)



**COMPASSO/SPRING JACK**  
Front: K3.015  
Rear: K3.014



## Caratteristiche Features

### *absolute 480*



**APERTURA/OPENING**  
Dual Side



**CODICE/CODE**  
22.315  
8010682037951 (EAN)



**FISSAGGIO/FIXING KIT**  
K9.009



**CARICO MAX./MAX LOAD**  
75Kg



**CAPACITA'/CAPACITY**  
480  
390 lt (effettiva/real)



**SERRATURA/LOCK**  
2 centralizzate/2 centralized  
(K3.013)



**MISURE/MEASURES**  
1930 x 740 x 370 mm  
1840 x 640 x 360 mm (interne/internal)



**COMPASSO/SPRING JACK**  
Front: K3.015  
Rear: K3.014



**"E' strano. Proprio quando penso di essere andato il più lontano possibile,  
scopro che posso spingermi ancora oltre."**

**It's strange. Just when I think I've gone as far as possible,  
I find that I can go even further.**

**(A.SENNA)**



# Box da tetto Roof boxes

Garantee  
3  
years

PS  
MATERIAL

UV  
11

EASYFIX

CityCrash

grigio scuro opaco - matt dark gray



> *all-time*

# Caratteristiche Features

*all-time 320*



**APERTURA/OPENING**

Right Side



**CODICE/CODE**

22.300  
8010682037906 (EAN)



**FISSAGGIO/FIXING KIT**

K9.009



**CARICO MAX./MAX LOAD**

50 Kg



**CAPACITA'/CAPACITY**

320  
240 lt (effettiva/real)



**SERRATURA/LOCK**

1 pulsante/1 push button  
(K3.003)



**MISURE/MEASURES**

1330 x 735 x 365 mm  
1240 x 675 x 355 mm (interne/internal)



**COMPASSO/SPRING JACK**

Front: K3.011  
Rear: K3.010



## Caratteristiche Features

*all-time 400*



**APERTURA/OPENING**  
Right Side



**CODICE/CODE**

22.304  
8010682037913 (EAN)



**FISSAGGIO/FIXING KIT**

K9.009



**CARICO MAX./MAX LOAD**

75 Kg



**CAPACITA'/CAPACITY**

400  
330 lt (effettiva/real)



## Caratteristiche Features

*all-time 480*



**APERTURA/OPENING**  
Right Side



**CODICE/CODE**

22.305  
8010682037920 (EAN)



**FISSAGGIO/FIXING KIT**

K9.009



**CARICO MAX./MAX LOAD**

75Kg



**CAPACITA'/CAPACITY**

480  
390 lt (effettiva/real)



**SERRATURA/LOCK**

1 centralizzata/1 centralized  
(K3.013)



**MISURE/MEASURES**

1462 x 867 x 375 mm  
1372 x 807 x 365 mm (interne/internal)



**COMPASSO/SPRING JACK**

Front: K3.011  
Rear: K3.010



**SERRATURA/LOCK**

1 centralizzata/1 centralized  
(K3.013)



**MISURE/MEASURES**

1930 x 740 x 370 mm  
1840 x 680 x 360 mm (interne/internal)



**COMPASSO/SPRING JACK**

Front: K3.011  
Rear: K3.010





**"Se Dio voleva che camminassimo,  
perchè ci ha dato dei piedi che si adattano benissimo ai pedali dell'auto?"**

**If God had meant for us to walk,  
why did he give us feet that fit car pedals?**

**(S.MOSS)**



# Box da tetto Roof boxes

5 years Guarantee

PS MATERIAL

UV

EASYFIX

CityCrash



nero goffrato - embossed black



> reef

# Caratteristiche Features

reef 270



APERTURA/OPENING

Right Side



IL PIU' PICCOLO  
The smallest



CODICE/CODE

22.210  
8010682036312 (EAN)



FISSAGGIO/FIXING KIT

K9.042



CARICO MAX./MAX LOAD

50 Kg



CAPACITA'/CAPACITY

270  
220 lt (effettiva/real)



SERRATURA/LOCK

1 pulsante/1 push button  
(K3.003)



MISURE/MEASURES

1180 x 760 x 390 mm  
1090 x 700 x 380 mm (interne/internal)



COMPASSO/SPRING JACK

Front: K3.014  
Rear: K3.014





**EXTRA CAPIENZA**  
Extra capacity



## Caratteristiche Features

*reef 390*



**APERTURA/OPENING**  
Dual Side



**CODICE/CODE**

22.214  
8010682036374 (EAN)



**FISSAGGIO/FIXING KIT**

K9.042



**CARICO MAX./MAX LOAD**

75 Kg



**CAPACITA'/CAPACITY**

390  
335 lt (effettiva/real)



**SERRATURA/LOCK**

2 centralizzate/centralized  
(K3.013)



**MISURE/MEASURES**

1250 x 1020 x 400 mm  
1160 x 920 x 390 mm (interne/internal)



**COMPASSO/SPRING JACK**

Front: K3.014  
Rear: K3.014



**NUOVO ARRIVATO**  
New Arrival



## Caratteristiche Features

*reef 520*



**APERTURA/OPENING**  
Dual Side



**CODICE/CODE**

22.215  
8010682052800 (EAN)



**FISSAGGIO/FIXING KIT**

K9.042



**CARICO MAX./MAX LOAD**

75Kg



**CAPACITA'/CAPACITY**

520  
450 lt (effettiva/real)



**SERRATURA/LOCK**

2 centralizzate/centralized  
(K3.013)



**MISURE/MEASURES**

1776 x 938 x 390 mm  
1686 x 838 x 380 mm (interne/internal)



**COMPASSO/SPRING JACK**

Front: K3.014  
Rear: K3.014





IL PIU' VENDUTO  
Best Seller



# Caratteristiche Features

*reef 580*



**APERTURA/OPENING**

Dual Side



**CODICE/CODE**

22.216  
8010682034035 (EAN)



**FISSAGGIO/FIXING KIT**

K9.042



**CARICO MAX./MAX LOAD**

75 Kg



**CAPACITA'/CAPACITY**

580  
460 lt (effettiva/real)



**SERRATURA/LOCK**

2 centralizzate/2 centralized  
(K3.013)



**MISURE/MEASURES**

1985 x 890 x 395 mm  
1895 x 790 x 385 mm (interne/internal)



**COMPASSO/SPRING JACK**

Front: K3.014  
Rear: K3.014

**"Per essere il primo devi innanzitutto tagliare il traguardo"**

To be the first you must first cross the finish line

(S.MOSS)



# Box da tetto Roof boxes

Guarantee  
5  
years

PS  
MATERIAL

UV  
11

EASYFIX

CityCrash



> *helios*

# Caratteristiche Features

*helios 320*



**APERTURA/OPENING**  
Right Side



**CODICE/CODE**

22.290  
8010682035698 (EAN)



**FISSAGGIO/FIXING KIT**

K9.009



**CARICO MAX./MAX LOAD**

50 Kg



**CAPACITA'/CAPACITY**

320  
240 lt (effettiva/real)



**SERRATURA/LOCK**

1 pulsante/1 push button  
(K3.003)



**MISURE/MEASURES**

1325 x 725 x 370 mm  
1235 x 665 x 360 mm (interne/internal)



**COMPASSO/SPRING JACK**

Front: K3.015  
Rear: K3.014



## Caratteristiche Features

### helios 400



**APERTURA/OPENING**  
Dual Side



**CODICE/CODE**  
22.294  
8010682035704 (EAN)



**FISSAGGIO/FIXING KIT**  
K9.009



**CARICO MAX./MAX LOAD**  
75 Kg



**CAPACITA'/CAPACITY**  
400  
330 lt (effettiva/real)



**SERRATURA/LOCK**  
2 centralizzate/2 centralized  
(K3.013)



**MISURE/MEASURES**  
1440 x 860 x 375 mm  
1350 x 760 x 365 mm (interne/internal)



**COMPASSO/SPRING JACK**  
Front: K3.015  
Rear: K3.014



## Caratteristiche Features

### helios 400 camou



**DI TENDENZA**  
Super Cool



**APERTURA/OPENING**  
Dual Side



**CODICE/CODE**  
22.294 camou  
8010682042290 (EAN)



**FISSAGGIO/FIXING KIT**  
K9.009



**CARICO MAX./MAX LOAD**  
75Kg



**CAPACITA'/CAPACITY**  
400  
330 lt (effettiva/real)



**SERRATURA/LOCK**  
2 centralizzate/2 centralized  
(K3.013)



**MISURE/MEASURES**  
1440 x 860 x 375 mm  
1350 x 760 x 365 mm (interne/internal)



**COMPASSO/SPRING JACK**  
Front: K3.015  
Rear: K3.014



## Caratteristiche Features

### helios 480



**APERTURA/OPENING**  
Dual Side



**CODICE/CODE**  
22.295  
8010682035711 (EAN)



**FISSAGGIO/FIXING KIT**  
K9.009



**CARICO MAX./MAX LOAD**  
75 Kg



**CAPACITA'/CAPACITY**  
480  
390 lt (effettiva/real)



**SERRATURA/LOCK**  
2 centralizzate/2 centralized  
(K3.013)



**MISURE/MEASURES**  
1950 x 738 x 360 mm  
1860 x 638 x 350 mm (interne/internal)



**COMPASSO/SPRING JACK**  
Front: K3.015  
Rear: K3.014



## Caratteristiche Features

### helios 480 road



**DI TENDENZA**  
Super Cool



**APERTURA/OPENING**  
Dual Side



**CODICE/CODE**  
22.295 road  
8010682046731 (EAN)



**FISSAGGIO/FIXING KIT**  
K9.009



**CARICO MAX./MAX LOAD**  
75Kg



**CAPACITA'/CAPACITY**  
480  
390 lt (effettiva/real)



**SERRATURA/LOCK**  
2 centralizzate/2 centralized  
(K3.013)



**MISURE/MEASURES**  
1950 x 738 x 360 mm  
1860 x 638 x 350 mm (interne/internal)



**COMPASSO/SPRING JACK**  
Front: K3.015  
Rear: K3.014



**"La velocità non è pericolosa.  
Più forte vai, prima raggiungi il punto in cui sei finalmente al sicuro."**

**Speed is not dangerous.**

**The faster you go, the sooner you reach the point where you are finally safe**

**(M. TRINTIGNANT)**



# Box da tetto Roof boxes

3 years Guarantee

PS MATERIAL

UV

EASYFIX

CityCrash

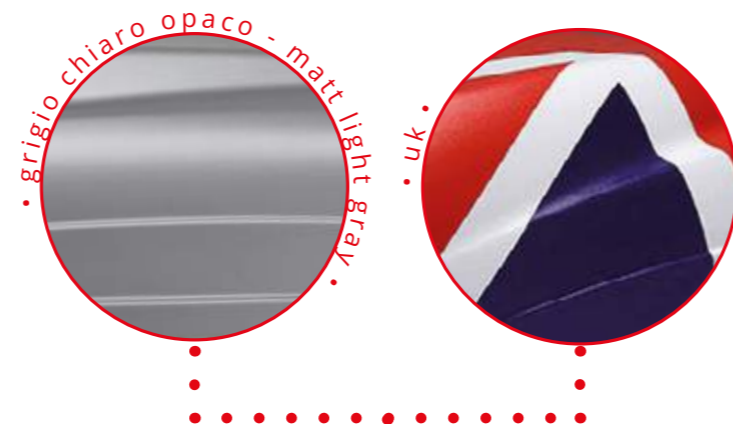

> **Krono**

# Caratteristiche Features

**Krono 320**



**PRIMO PREZZO**  
Entry level



**APERTURA/OPENING**  
Right Side



**CODICE/CODE**

22.200  
8010682032451 (EAN)



**FISSAGGIO/FIXING KIT**

K9.009



**CARICO MAX./MAX LOAD**

50 Kg



**CAPACITA'/CAPACITY**

320  
240 lt (effettiva/real)



**SERRATURA/LOCK**

1 pulsante/1 push button  
(K3.003)



**MISURE/MEASURES**

1325 x 725 x 370 mm  
1235 x 665 x 360 mm (interne/internal)



**COMPASSO/SPRING JACK**

Front: K3.011  
Rear: K3.010



DI TENDENZA  
Super Cool



## Caratteristiche Features

*Krono 320 UK*



**APERTURA/OPENING**

Right Side



**CODICE/CODE**

22.200 uk  
8010682040395 (EAN)



**FISSAGGIO/FIXING KIT**

K9.009



**CARICO MAX./MAX LOAD**

50 Kg



**CAPACITA'/CAPACITY**

320  
240 lt (effettiva/real)



**SERRATURA/LOCK**

1 pulsante/1 push button  
(K3.003)



**MISURE/MEASURES**

1325 x 725 x 370 mm  
1235 x 665 x 360 mm (interne/internal)



**COMPASSO/SPRING JACK**

Front: K3.011  
Rear: K3.010



## Caratteristiche Features

*Krono 400*



**APERTURA/OPENING**

Right Side



**CODICE/CODE**

22.204  
8010682034141 (EAN)



**FISSAGGIO/FIXING KIT**

K9.009



**CARICO MAX./MAX LOAD**

75Kg



**CAPACITA'/CAPACITY**

400  
330 lt (effettiva/real)



**SERRATURA/LOCK**

1 centralizzata/1 centralized  
(K3.013)



**MISURE/MEASURES**

1440 x 860 x 375 mm  
1350 x 800 x 365 mm (interne/internal)



**COMPASSO/SPRING JACK**

Front: K3.011  
Rear: K3.010







## Caratteristiche Features

*Krono 480*



### APERTURA/OPENING

Right Side



### CODICE/CODE

22.205  
8010682032468 (EAN)



### FISSAGGIO/FIXING KIT

K9.009



### CARICO MAX./MAX LOAD

75 Kg



### CAPACITA'/CAPACITY

480  
390 lt (effettiva/real)



### SERRATURA/LOCK

1 centralizzata/1 centralized  
(K3.013)



### MISURE/MEASURES

1950 x 738 x 360 mm  
1860 x 678 x 350 mm (interne/internal)



### COMPASSO/SPRING JACK

Front: K3.011  
Rear: K3.010

**"La pista è la mia tela, la mia auto è il mio pennello"**

The track is my canvas, and the car is my brush.

(G.HILL)



# Box da tetto Roof boxes

Guarantee  
5  
years

PS  
MATERIAL

UV  
17

EASYFIX

CityCrash

nero lucido - glossy black.

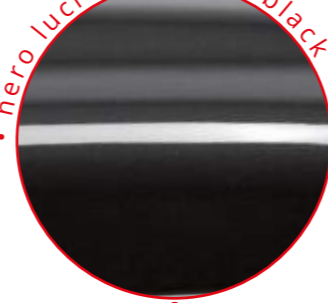

> **arjes**

# Caratteristiche Features

*arjes 280*



PER GLI AMANTI DELLO SCI E DELLA PESCA  
For ski and fishing lovers



**APERTURA/OPENING**  
Right Side



**CODICE/CODE**  
22.172  
8010682025408 (EAN)



**FISSAGGIO/FIXING KIT**  
K9.009



**CARICO MAX./MAX LOAD**  
50 Kg



**CAPACITA'/CAPACITY**  
280  
225 lt (effettiva/real)



**SERRATURA/LOCK**  
1 centralizzata/1 centralized  
(K3.013)



**MISURE/MEASURES**  
2280 x 485 x 320 mm  
2190 x 425 x 310 mm (interne/internal)



**COMPASSO/SPRING JACK**  
Front: K3.015  
Rear: K3.014



## Caratteristiche Features

### arjes 320



**APERTURA/OPENING**

Right Side



**CODICE/CODE**

22.170  
8010682025057 (EAN)



**FISSAGGIO/FIXING KIT**

K9.009



**CARICO MAX./MAX LOAD**

50 Kg



**CAPACITA'/CAPACITY**

320  
240 lt (effettiva/real)



**SERRATURA/LOCK**

1 pulsante/1 push button  
(K3.003)



**MISURE/MEASURES**

1330 x 735 x 365 mm  
1240 x 675 x 355 mm (interne/internal)



**COMPASSO/SPRING JACK**

Front: K3.015  
Rear: K3.014



## Caratteristiche Features

### arjes 480



**APERTURA/OPENING**

Dual Side



**CODICE/CODE**

22.175  
8010682027990 (EAN)



**FISSAGGIO/FIXING KIT**

K9.009



**CARICO MAX./MAX LOAD**

75 Kg



**CAPACITA'/CAPACITY**

480  
390 lt (effettiva/real)



**SERRATURA/LOCK**

2 centralizzate/2 centralized  
(K3.013)



**MISURE/MEASURES**

1970 x 738 x 370 mm  
1880 x 638 x 360 mm (interne/internal)



**COMPASSO/SPRING JACK**

Front: K3.015  
Rear: K3.014



**“Quando il motore va bene è una musica incomparabile”**

**When the engine goes well it is an incomparable music**

**(J.M. FANGIO)**



# Box da tetto Roof boxes

Garantie  
3  
years

PS  
MATERIAL

UV

EASYFIX

CityCrash

grigio opaco chiaro - light matt gray



> *hydra*

# Caratteristiche Features

*hydra 280*



PER GLI AMANTI DELLO SCI E DELLA PESCA  
For ski and fishing lovers



APERTURA/OPENING  
Right Side



CODICE/CODE

22.182  
8010682025330 (EAN)



FISSAGGIO/FIXING KIT

K9.009



CARICO MAX./MAX LOAD

50 Kg



CAPACITA'/CAPACITY

280  
225 lt (effettiva/real)



SERRATURA/LOCK

1 centralizzata/1 centralized  
(K3.013)



MISURE/MEASURES

2280 x 485 x 320 mm  
2190 x 425 x 310 mm (interne/internal)



COMPASSO/SPRING JACK

Front: K3.011  
Rear: K3.010





## Caratteristiche Features

### hydra 320



**APERTURA/OPENING**  
Right Side



**CODICE/CODE**  
22.180  
8010682041903 (EAN)



**FISSAGGIO/FIXING KIT**  
K9.009



**CARICO MAX./MAX LOAD**  
50 Kg



**CAPACITA'/CAPACITY**  
320  
240 lt (effettiva/real)



**SERRATURA/LOCK**  
1 pulsante/1 push button  
(K3.003)



**MISURE/MEASURES**  
1330 x 735 x 365 mm  
1240 x 675 x 355 mm (interne/internal)



**COMPASSO/SPRING JACK**  
Front: K3.011  
Rear: K3.010



## Caratteristiche Features

### hydra 480



**APERTURA/OPENING**  
Right Side



**CODICE/CODE**  
22.185  
8010682025392 (EAN)



**FISSAGGIO/FIXING KIT**  
K9.009



**CARICO MAX./MAX LOAD**  
75 Kg



**CAPACITA'/CAPACITY**  
480  
390 lt (effettiva/real)



**SERRATURA/LOCK**  
1 centralizzata/1 centralized  
(K3.013)



**MISURE/MEASURES**  
1970 x 738 x 370 mm  
1880 x 678 x 360 mm (interne/internal)



**COMPASSO/SPRING JACK**  
Front: K3.011  
Rear: K3.010



**"L'automobilismo fa parte di me, del mio corpo.  
Quattro ruote, un sedile, un volante. é questa la mia vita"**

Motor racing is part of me, of my body.

Four wheels, a seat, a steering wheel. this is my life

**(A. SENNA)**



# Box da tetto Roof boxes

5 years  
Guarantee

PS  
MATERIAL

UV  
11

EASYFIX

CityCrash

• nero lucido - glossy black •



> **pegaso**

# Caratteristiche Features

*pegaso 320*



**APERTURA/OPENING**  
Right Side



**CODICE/CODE**

22.250  
8010682035667 (EAN)



**FISSAGGIO/FIXING KIT**

K9.009



**CARICO MAX./MAX LOAD**

50 Kg



**CAPACITA'/CAPACITY**

320  
240 lt (effettiva/real)



**SERRATURA/LOCK**

1 pulsante/1 push button  
(K3.003)



**MISURE/MEASURES**

1320 x 745 x 365 mm  
1230 x 685 x 355 mm (interne/internal)



**COMPASSO/SPRING JACK**

Front: K3.015  
Rear: K3.014





# Caratteristiche Features

*pegaso 450*



## APERTURA/OPENING

Dual Side



## CODICE/CODE

22.255  
8010682035681 (EAN)



## FISSAGGIO/FIXING KIT

K9.009



## CARICO MAX./MAX LOAD

75 Kg



## CAPACITA'/CAPACITY

450  
375 lt (effettiva/real)



## SERRATURA/LOCK

2 centralizzate/2 centralized  
(K3.013)



## MISURE/MEASURES

1950 x 770 x 380 mm  
1860 x 670 x 370 mm (interne/internal)



## COMPASSO/SPRING JACK

Front: K3.015  
Rear: K3.014

**"Nella vita capita che, abbassando lo sguardo per cercare ciò che hai perso,**

**scorgi proprio per questo qualcos'altro che vale la pena raccogliere."**

In life it happens that, looking down to look for what you have lost,

for this you see something else that is worth collecting.

**(A. ZANARDI)**

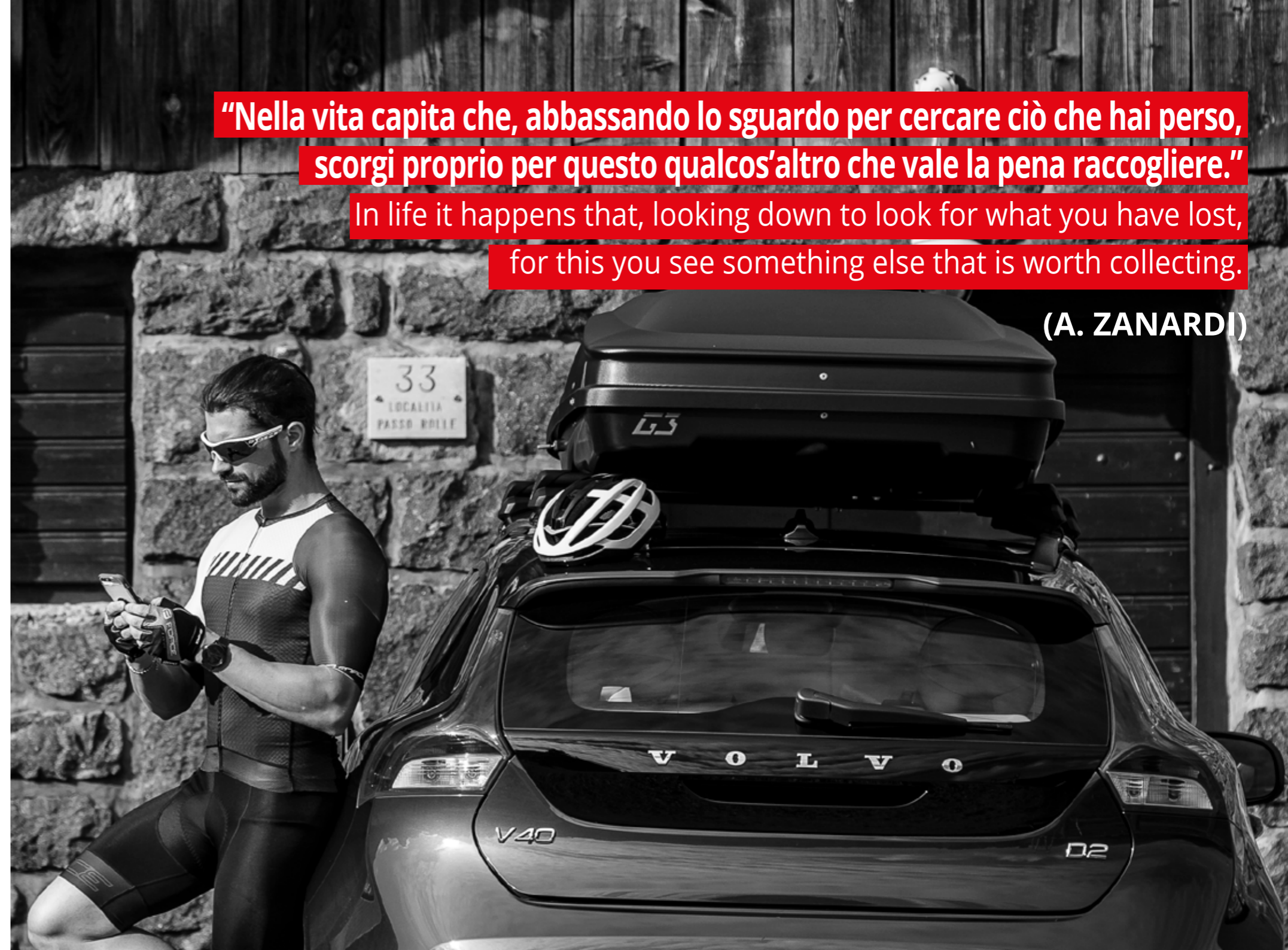

# Box da tetto Roof boxes

Garantie  
3  
years

PS  
MATERIAL

UV

EASYFIX

CityCrash

grigio opaco chiaro - light matt gray



> **sirio**

# Caratteristiche Features

*sirio 320*



**APERTURA/OPENING**  
Right Side



**CODICE/CODE**

22.160  
8010682024524 (EAN)



**FISSAGGIO/FIXING KIT**

K9.009



**CARICO MAX./MAX LOAD**

50 Kg



**CAPACITA'/CAPACITY**

320  
240 lt (effettiva/real)



**SERRATURA/LOCK**

1 pulsante/1 push button  
(K3.003)



**MISURE/MEASURES**

1320 x 745 x 365 mm  
1230 x 685 x 355 mm (interne/internal)



**COMPASSO/SPRING JACK**

Front: K3.011  
Rear: K3.010





# Caratteristiche Features

## *sirio 450*



**APERTURA/OPENING**

Right Side



**CODICE/CODE**

22.165  
8010682028065 (EAN)



**FISSAGGIO/FIXING KIT**

K9.009



**CARICO MAX./MAX LOAD**

75 Kg



**CAPACITA'/CAPACITY**

450  
375 lt (effettiva/real)



**SERRATURA/LOCK**

1 centralizzata/1 centralized  
(K3.013)



**MISURE/MEASURES**

1950 x 770 x 380 mm  
1860 x 710 x 370 mm (interne/internal)



**COMPASSO/SPRING JACK**

Front: K3.011  
Rear: K3.010



**"La macchina da corsa perfetta è quella che si rompe un attimo dopo il traguardo."**

The perfect racing car is the one that breaks down right after the finishing line.

(F. FERRARI)



# Box da tetto Roof boxes

Guarantee  
3  
years

PS  
MATERIAL

UV

EASYFIX

CityCrash

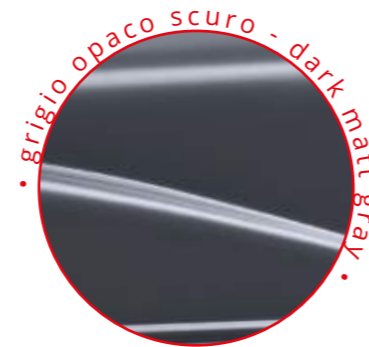

grigio opaco scuro - dark matt gray



> cargo

# Caratteristiche Features

*cargo 4*



APERTURA/OPENING

Right Side



ICONICO  
Iconic



CODICE/CODE

22.104  
8010682009668 (EAN)



FISSAGGIO/FIXING KIT

K9.009



CARICO MAX./MAX LOAD

75 Kg



CAPACITA'/CAPACITY

300 lt (effettiva/real)



SERRATURA/LOCK

2 pulsanti/2 push button  
(K3.003)



MISURE/MEASURES

1290 x 890 x 399 mm  
1200 x 830 x 389 mm (interne/internal)



COMPASSO/SPRING JACK

Front: K3.010  
Rear: K3.010



ICONICO  
Iconic



## Caratteristiche Features

*cargo 5*



APERTURA/OPENING  
Right Side



**CODICE/CODE**  
22.105  
8010682009675 (EAN)



**FISSAGGIO/FIXING KIT**  
K9.009



**CARICO MAX./MAX LOAD**  
75 Kg



**CAPACITA'/CAPACITY**  
355 lt (effettiva/real)



**SERRATURA/LOCK**  
2 pulsanti/2 push button  
(K3.003)



**MISURE/MEASURES**  
1776 x 760 x 380 mm  
1686 x 700 x 370 mm (interne/internal)



**COMPASSO/SPRING JACK**  
Front: K3.010  
Rear: K3.010



ICONICO  
Iconic



## Caratteristiche Features

*cargo 6*



APERTURA/OPENING  
Right Side



**CODICE/CODE**  
22.106  
8010682009682 (EAN)



**FISSAGGIO/FIXING KIT**  
K9.009



**CARICO MAX./MAX LOAD**  
75 Kg



**CAPACITA'/CAPACITY**  
410 lt (effettiva/real)



**SERRATURA/LOCK**  
2 pulsanti/2 push button  
(K3.003)



**MISURE/MEASURES**  
2200 x 730 x 410 mm  
2110 x 670 x 400 mm (interne/internal)



**COMPASSO/SPRING JACK**  
Front: K3.010  
Rear: K3.010



**G3**

www.g3spa.it

# Accessori Box Box accessories

Più spazio ai vostri viaggi *More space for your journeys*

## Accessori Box Box accessories

> *serrature locks*

### Serratura pulsante | Push-button lock



**CODICE/CODE**

K3.003  
8010682026320 (EAN)

### Cilindro completo | Cylinder lock



Per serratura centralizzata  
con 2 chiavi complete.

For centralized lock with 2 keys.



**CODICE/CODE**

K3.013.ST4A  
8010682036534 (EAN)

## Accessori Box Box accessories

> *cinghie belts*

### Kit fissaggio interno | Internal fixing straps



**2 PCS**



**CODICE/CODE**

K3.032  
8010682026757 (EAN)

### Kit fissaggio interno | Internal fixing straps



**3 PCS**



**CODICE/CODE**

K3.038  
8010682033373 (EAN)

## Accessori Box Box accessories

> *fissaggi fixing*



CityCrash

### Kit fissaggio esterno | External fixing kit



Per barre con sezione fino a 60 mm.

For bars width up to 60 mm.



**CODICE/CODE**

K9.009  
8010682025781 (EAN)

## Accessori Box Box accessories

> *fissaggi fixing*



CityCrash

### Kit fissaggio a "T" | T-Shaped Fixing kit

L = 25 mm  
D = 19 mm  
H = 5,5 mm



Consente di fissare qualsiasi accessorio sulle barre in alluminio in modo sicuro e invisibile.

It allows you to fix any accessory on the aluminum bars in a safe and invisible way.



**CODICE/CODE**

K9.041  
8010682048131 (EAN)

### Kit fissaggio elegance | Fixing kit elegance



Universale, adatto a tutti i tipi di barre fino a 90 mm.

Universal, suitable for all types of roof bars width up to 90 mm.



**CODICE/CODE**

K9.042  
8010682039504 (EAN)

### Kit fissaggio rapid | Fixing kit rapid



Universale, adatto a tutti i tipi di barre fino a 90 mm.

Universal, suitable for all types of roof bars width up to 90 mm.



**CODICE/CODE**

K9.142  
8010682052251 (EAN)



## Accessori Box Box accessories

> *compassi spring jack*



### Compasso in plastica | Plastic Spring jack



**CODICE/CODE**

K3.010  
8010682026337 (EAN)

### Compasso in plastica | Plastic Spring jack



**CODICE/CODE**

K3.011  
8010682026344 (EAN)

## Accessori Box Box accessories

> *compassi spring jack*



### Compasso in plastica | Plastic Spring jack



Meccanismo di sgancio  
semplice e veloce.

Quick and easy release  
mechanism.



**CODICE/CODE**

K3.014  
8010682039788 (EAN)

### Compasso in plastica | Plastic Spring jack



Meccanismo di sgancio  
semplice e veloce.

Quick and easy release  
mechanism.



**CODICE/CODE**

K3.015  
8010682045505 (EAN)

## Accessori Box Box accessories

> *kit montaggio mounting kit*

### Kit montaggio Box 22.654 | Box mounting kit 22.654



Set componenti per montaggio box bicube 400+ disassembled.

Disassembled bicube box assembly components set 400+.



**CODICE/CODE**

K9.051  
8010682052862 (EAN)

> *sacca box box bag*



Sacca box G3 che proteggerà i tuoi accessori da polvere e graffi.

G3 bag protecting your roofbox from dust and scratches.



**CODICE/CODE**

69.901  
8010682051926 (EAN)

## Accessori Box Box accessories

> *espositore display*

### Espositore Box | Box display rack

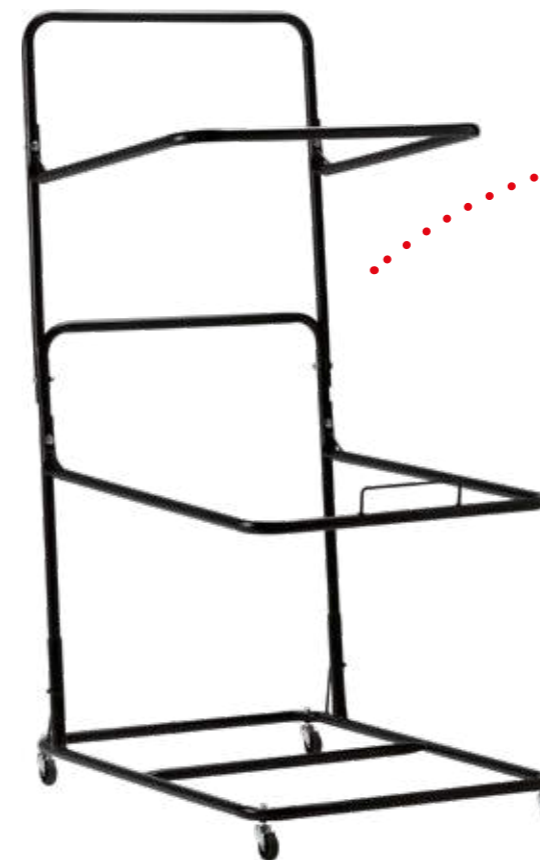

**X3 BOX**

**L = 88 mm  
D = 100 mm  
H = 159 mm**



**CODICE/CODE**

22.999.01  
8010682049152 (EAN)

**G3**



**Barre porta tutto**  
**Roof bars**

---

Più spazio ai vostri viaggi *More space for your journeys*





# La nostra qualità Our quality

**>**  **CITY CRASH**  
Tutta la gamma prodotti G3 ha brillantemente superato i test ISO/PAS. Testati con una forza di impatto pari a 8G ed un peso che varia dai 50 kg ai 75 kg.

**>**  **EASY-SYSTEM**  
Efficiente sistema di montaggio rapido (tempo non superiore a 15 min.) ottenuto grazie al lavoro di pre-montaggio ed alla cura per i dettagli che G3 mette in tutti i suoi prodotti.

**>**  **ISO/PAS**  
Normativa di riferimento internazionale che racchiude tutte le principali normative Europee.

**>**  **MATERIALE**  
Alluminio: profilo in alluminio estruso.

**>**  **MATERIALE**  
Acciaio: tubo in acciaio rivestito in materiale plastico.

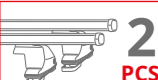
**>**  **PCS**  
Numero di pezzi presenti in ogni confezione.

**CITY CRASH**  
G3 complete range has successfully passed the ISO/PAS tests. All the bars are tested with an impact force equal to 8G and a weight range from 50 kg to 75 kg.

**EASY-SYSTEM**  
Efficient and rapid assembly system (not more than 15 min.) achieved thanks to a pre-assembly work and the G3 attention to details.

**ISO/PAS**  
International standard regulation that encloses main European rules.

**MATERIALE**  
Aluminium: extruded aluminium profile.

**MATERIALE**  
Steel: steel pipe covered by plastic material.

**PCS**  
Number of pieces in each pack.

**>**  **EASYFIX**  
Montaggio rapido del prodotto ottenuto senza bisogno di attrezzi aggiuntivi.

**>**  **CARICO MASSIMO**  
Carico massimo indicativo per il quale la coppia di barre è stata testata.

**>**  **KIT FISSAGGIO**  
Il kit di fissaggio sarà incluso/non incluso all'interno della confezione delle barre portatutto.

**>**  **SERRATURA**  
Il prodotto include/non include una serratura centralizzata antifurto con sopra inciso un codice di 3 cifre, utile in caso di smarrimento delle chiavi.

**AD OGNI TETTO LA SUA BARRA PORTA TUTTO**  
La linea di barre porta tutto per auto G3 è composta da tre differenti prodotti (Pacific, Open e Clop), ognuno dei quali è in grado di soddisfare particolari caratteristiche del tetto per rispondere nel migliore dei modi ad ogni esigenza di fissaggio.

**EASYFIX**  
Easy and fast assembling of the product without any additional tool.

**MAX LOADING CAPACITY**  
Maximum indicative loading weight for which the pair of bars has been tested.

**FIXING KIT**  
Fixing kit will be included/not included in roofbars package.

**LOCKING KIT**  
The product includes a centralized antitheft lock with an engraved 3 digits code, useful in case of key loss.

**TO EACH ROOF ITS OWN ROOF BAR**  
G3 roof bars range is composed by three different product lines (Pacific, Open and Clop), everyone satisfying some particular and specific roof features in order to meet every type of fixation needs.

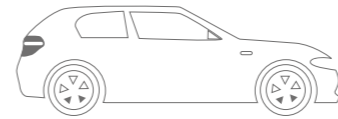
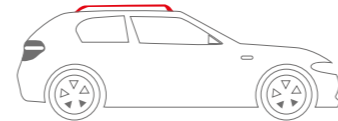
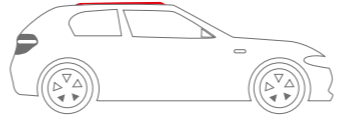
	<b>&gt;</b> <i><b>pacific - pacific.basic</b></i> <i><b>pacific.basichitless - pacific.airflow</b></i> Barre porta tutto specifiche / Specific Roof bars
	<b>&gt;</b> <i><b>open - open.basic</b></i> Barre portatutto per railing aperti / Open rails roof bars
	<b>&gt;</b> <i><b>clop - clop.infinity - clop.airflow</b></i> Barre portatutto per railing integrati e railing aperti Roof bars for integrated railing and open railing



# Barre porta tutto Roof bars

Garanzia  
**2**  
years

QUALITY  
TEST  
ISO PAS 11154

**1** BOX  
not included  
FIXING KIT

**EASYFIX**

**50 Kg**  
MAX LOAD

**2**  
PCS

included  
Cod. 69.015  
LOCK KIT

CityCrash



# Caratteristiche Features

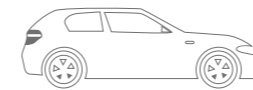

**PER AUTO SENZA CORRIMANO**  
For cars without railing system



**MATERIALE/MATERIAL**

Alluminio/Aluminium



**CODICE/CODE**

64.110  
8010682042993 (EAN)



**MISURE/MEASURES**

110 cm (lunghezza/length)



**CARICO MAX./MAX LOAD**

50 Kg



**SERRATURA/LOCK**

69.015  
Antifurto/Antitheft



**TAPPO/CAP**

K60.013G3



## Caratteristiche Features

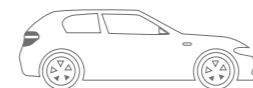

**PER AUTO SENZA CORRIMANO**  
For cars without railing system



**MATERIALE/MATERIAL**  
Alluminio/Aluminium



**CODICE/CODE**

64.130  
8010682042986 (EAN)



**MISURE/MEASURES**

127 cm (lunghezza/length)



**CARICO MAX./MAX LOAD**

50 Kg



**SERRATURA/LOCK**

69.015  
Antifurto/Antitheft



**TAPPO/CAP**

K60.013G3



## Caratteristiche Features



**PER AUTO SENZA CORRIMANO**  
For cars without railing system



**MATERIALE/MATERIAL**  
Alluminio/Aluminium



**CODICE/CODE**

64.150  
8010682043679 (EAN)



**MISURE/MEASURES**

147 cm (lunghezza/length)



**CARICO MAX./MAX LOAD**

50 Kg



**SERRATURA/LOCK**

69.015  
Antifurto/Antitheft



**TAPPO/CAP**

K60.013G3



**“ Se vuoi raggiungere il limite, intanto devi superarlo”**

If you want to reach the limit, in the meantime you have to overcome it

(G.VILLENEUVE)



# Barre porta tutto Roof bars

Garanzia  
**2**  
years

QUALITY  
TEST  
ISO PAS 11154

**1** BOX  
not included  
FIXING KIT

**EASYFIX**

**50 Kg**  
MAX LOAD

**2**  
PCS

Cod. 69.015  
**LOCK KIT**

CityCrash



> *pacific*

# Caratteristiche Features

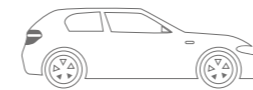

**PER AUTO SENZA CORRIMANO**  
For cars without railing system

**MATERIALE/MATERIAL**

Acciaio/Steel



**CODICE/CODE**

65.110  
8010682042979 (EAN)



**MISURE/MEASURES**

110 cm (lunghezza/length)



**CARICO MAX./MAX LOAD**

50 Kg



**SERRATURA/LOCK**

Opzionale/Optional  
(cod. 69.015)



**TAPPO/CAP**

K60.309G3





## Caratteristiche Features

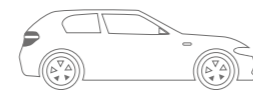

**PER AUTO SENZA CORRIMANO**  
For cars without railing system



### MATERIALE/MATERIAL

Acciaio/Steel



### CODICE/CODE

65.130  
8010682042962 (EAN)



### MISURE/MEASURES

127 cm (lunghezza/length)



### CARICO MAX./MAX LOAD

50 Kg



### SERRATURA/LOCK

Opzionale/Optional  
(cod. 69.015)



### TAPPO/CAP

K60.309G3



## Caratteristiche Features

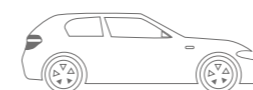

**PER AUTO SENZA CORRIMANO**  
For cars without railing system



### MATERIALE/MATERIAL

Acciaio/Steel



### CODICE/CODE

65.150  
8010682052046 (EAN)



### MISURE/MEASURES

147 cm (lunghezza/length)



### CARICO MAX./MAX LOAD

50 Kg



### SERRATURA/LOCK

Opzionale/Optional  
(cod. 69.015)



### TAPPO/CAP

K60.309G3

# Barre porta tutto Roof bars

Garantia  
**2**  
anni

QUALITY  
TEST  
ISO PAS 11154

**1** BOX  
included  
FIXING KIT

**EASYFIX**

**50 Kg**  
MAX LOAD

**2**  
PCS

CityCrash



> *pacific.basic*

# Caratteristiche Features

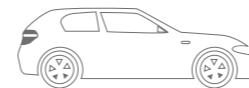





**SET COMPLETO DI BARRE E KIT**  
Complete set of bars and kits



**MATERIALE/MATERIAL**

Acciaio/Steel



 <b>CODICE/CODE</b>	 <b>KIT INCLUSO/KIT INCLUDED</b>	 <b>MISURE/MEASURES</b>	 <b>CARICO MAX./MAX LOAD</b>	 <b>TAPPO/CAP</b>
67.110.003 8010682045956 (EAN)	68.003	110 cm (lunghezza/length)	50 Kg	K60.309G3
67.110.009 8010682045857 (EAN)	68.009	110 cm (lunghezza/length)	50 Kg	K60.309G3
67.110.010 8010682045864 (EAN)	68.010	110 cm (lunghezza/length)	50 Kg	K60.309G3
67.110.011 8010682045949 (EAN)	68.011	110 cm (lunghezza/length)	50 Kg	K60.309G3
67.110.030 8010682045932 (EAN)	68.030	110 cm (lunghezza/length)	50 Kg	K60.309G3
67.110.047 8010682045925 (EAN)	68.047	110 cm (lunghezza/length)	50 Kg	K60.309G3
67.110.072 8010682045918 (EAN)	68.072	110 cm (lunghezza/length)	50 Kg	K60.309G3



# Caratteristiche Features

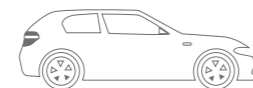

SET COMPLETO DI BARRE E KIT  
Complete set of bars and kits



## MATERIALE/MATERIAL

Acciaio/Steel



### CODICE/CODE

67.130.005  
8010682045901 (EAN)



### KIT INCLUSO/KIT INCLUDED

68.005



### MISURE/MEASURES

127 cm  
(lunghezza/length)



### CARICO MAX./MAX LOAD

50 Kg



### TAPPO/CAP

K60.309G3

67.130.008  
8010682045895 (EAN)

68.008

127 cm  
(lunghezza/length)

50 Kg

K60.309G3

67.130.010  
8010682045888 (EAN)

68.010

127 cm  
(lunghezza/length)

50 Kg

K60.309G3

67.110.011  
8010682045871 (EAN)

68.011

127 cm  
(lunghezza/length)

50 Kg

K60.309G3

**"La vita è correre. Il resto è soltanto attesa."**

Life is racing. Everything else is just waiting

**(E.FERRARI)**



# Barre porta tutto Roof bars

Guarantee  
**2**  
years

QUALITY  
TEST  
ISO PAS 11154

**1** BOX  
not included  
FIXING KIT

**X**  
EASYFIX

**50 Kg**  
MAX LOAD

**2**  
PCS

CityCrash



> *pacific.basic*hitless

# Caratteristiche Features

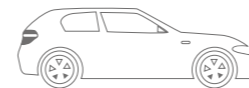

**PRIMO PREZZO**  
Entry Level



**MATERIALE/MATERIAL**  
Acciaio/Steel



**CODICE/CODE**

67.110  
8010682047387 (EAN)  
67.130  
8010682047776 (EAN)



**MISURE/MEASURES**

110 cm  
(lunghezza/length)  
127 cm  
(lunghezza/length)



**CARICO MAX./MAX LOAD**

50 Kg  
50 Kg



**TAPPO/CAP**

K60.309G3  
K60.309G3



# Barre porta tutto Roof bars

Guarantee  
**2**  
years

QUALITY  
TEST  
ISO PAS 11154

**1** BOX  
not included  
FIXING KIT

**EASYFIX**

**50 Kg**  
MAX LOAD

**2**  
PCS

Cod. 69.015  
**LOCK KIT**

CityCrash



> *pacific.airflow*

# Caratteristiche Features

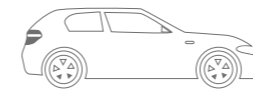

**PER AUTO SENZA CORRIMANO**  
For cars without railing system

**MATERIALE/MATERIAL**  
Alluminio/Aluminum



**CODICE/CODE**

64.210  
8010682052985 (EAN)



**MISURE/MEASURES**

110 cm (lunghezza/length)



**CARICO MAX./MAX LOAD**

50 Kg



**SERRATURA/LOCK**

Cod. 69.015



**TAPPO/CAP**

K60.012G3



## Caratteristiche Features

PER AUTO SENZA CORRIMANO  
For cars without railing system

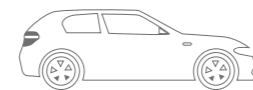

**MATERIALE/MATERIAL**  
Alluminio/Aluminum



**CODICE/CODE**

64.230  
8010682052978 (EAN)



**MISURE/MEASURES**

127 cm (lunghezza/length)



**CARICO MAX./MAX LOAD**

50 Kg



**SERRATURA/LOCK**

Cod. 69.015



**TAPPO/CAP**

K60.012G3



**"Datemi qualsiasi cosa a motore e io ve lo porterò a limite."**

Give me anything motorized and I'll take it to the limit.

(G.VILLENEUVE)

# Barre porta tutto Roof bars

Garantie  
**2**  
years

QUALITY  
TEST  
ISO PAS 11154

**EASYFIX**

**75 Kg**  
MAX LOAD

**2**  
PCS

included  
Cod. 69.011  
**LOCK KIT**



CityCrash



> *open*

# Caratteristiche Features

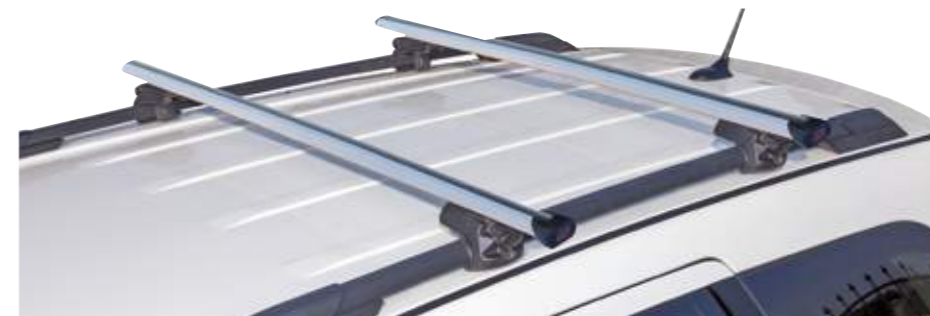
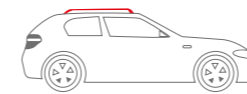

**INSTALLABILI**  
Installable

**MATERIALE/MATERIAL**  
Alluminio/Aluminium



**CODICE/CODE**

60.010  
8010682035834 (EAN)



**MISURE/MEASURES**

110 cm (lunghezza/length)



**CARICO MAX./MAX LOAD**

75 Kg



**SERRATURA/LOCK**

Cod. 69.011



**TAPPO/CAP**

K60.013G3





**INSTALLABILI**  
Installable



## Caratteristiche Features

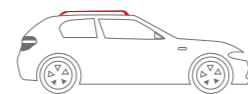

**MATERIALE/MATERIAL**  
Alluminio/Aluminium



**CODICE/CODE**

60.030  
8010682035841 (EAN)



**MISURE/MEASURES**

127 cm (lunghezza/length)



**CARICO MAX./MAX LOAD**

75 Kg



**SERRATURA/LOCK**

Cod. 69.011



**TAPPO/CAP**

K60.013G3



**INSTALLABILI**  
Installable



## Caratteristiche Features

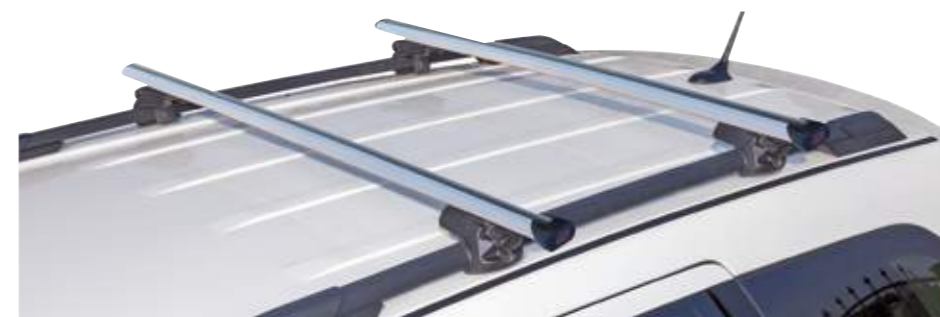
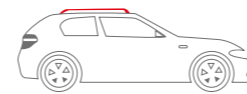

**MATERIALE/MATERIAL**  
Alluminio/Aluminium



**CODICE/CODE**

60.045  
8010682035858 (EAN)



**MISURE/MEASURES**

145 cm (lunghezza/length)



**CARICO MAX./MAX LOAD**

75 Kg



**SERRATURA/LOCK**

Cod. 69.011



**TAPPO/CAP**

K60.013G3





# Barre porta tutto Roof bars

Guarantee  
**2**  
years

QUALITY  
TEST  
ISO PAS 11154

**EASYFIX**

**75 Kg**  
MAX LOAD

**2**  
PCS



CityCrash



> *open.basic*

# Caratteristiche Features

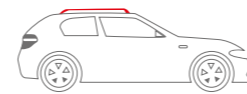

**MATERIALE/MATERIAL**

Acciaio/Steel



**CODICE/CODE**

61.122  
8010682042344 (EAN)



**MISURE/MEASURES**

122 cm (lunghezza/length)



**CARICO MAX./MAX LOAD**

75 Kg



**SERRATURA/LOCK**

No



**TAPPO/CAP**

K60.309G3



**PRIMO PREZZO**  
Entry Level



**"Quando uno corre, vive. E tutto quello che fa prima o dopo, è solo attesa"**

When one runs, he lives. And everything it does sooner or later is just waiting

(S.MCQUEEN)



# Barre porta tutto Roof bars

Garantie  
**2**  
years

QUALITY  
TEST  
ISO PAS 11154

**EASYFIX**

**75 Kg**  
MAX LOAD

**2**  
PCS

included  
Cod. 69.011  
**LOCK KIT**



CityCrash



> *clap*

# Caratteristiche Features



**ASSOLUTAMENTE INNOVATIVO**  
Absolutely Innovative

**MATERIALE/MATERIAL**  
Alluminio/Aluminium



**CODICE/CODE**

60.110  
8010682041231 (EAN)



**MISURE/MEASURES**

110 cm (lunghezza/length)



**CARICO MAX./MAX LOAD**

75 Kg



**SERRATURA/LOCK**

Cod. 69.011



**TAPPO/CAP**

K60.013G3



# Caratteristiche Features



**ASSOLUTAMENTE INNOVATIVO**  
Absolutely Innovative



**MATERIALE/MATERIAL**  
Alluminio/Aluminium



**CODICE/CODE**

60.130  
8010682041248 (EAN)



**MISURE/MEASURES**

127 cm (lunghezza/length)



**CARICO MAX./MAX LOAD**

75 Kg



**SERRATURA/LOCK**

Cod. 69.011



**TAPPO/CAP**

K60.013G3



**"I record sono fatti per essere battuti"**

Records are meant to be broken

(M.SCHUMACHER)

# Barre porta tutto Roof bars

Garantee  
**2**  
years

QUALITY  
TEST  
ISO PAS 11154

**EASYFIX**

**75 Kg**  
MAX LOAD

**2**  
PCS

Cod. 69.011  
**LOCK KIT**



CityCrash



> *clap*

# Caratteristiche Features



**ASSOLUTAMENTE INNOVATIVO**  
Absolutely Innovative

**MATERIALE/MATERIAL**

Acciaio/Steel



**CODICE/CODE**

61.110  
8010682041255 (EAN)



**MISURE/MEASURES**

110 cm (lunghezza/length)



**CARICO MAX./MAX LOAD**

75 Kg



**SERRATURA/LOCK**

Opzionale/Optional  
(cod. 69.011)



**TAPPO/CAP**

K60.309G3



## Caratteristiche Features



**ASSOLUTAMENTE INNOVATIVO**  
Absolutely Innovative



### MATERIALE/MATERIAL

Acciaio/Steel



### CODICE/CODE

61.130  
8010682041262 (EAN)



### MISURE/MEASURES

127 cm (lunghezza/length)



### CARICO MAX./MAX LOAD

75 Kg



### SERRATURA/LOCK

Opzionale/Optional  
(cod. 69.011)



### TAPPO/CAP

K60.309G3

**"La macchina migliore è quella che deve ancora essere costruita."**

The best car is the one that has yet to be built.

(E.FERRARI)



# Barre porta tutto Roof bars

Guarantee  
**2**  
years

QUALITY  
TEST  
ISO PAS 11154

 EASYFIX

**75 Kg**  
MAX LOAD

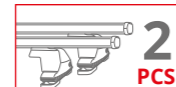
 **2**  
PCS

 included  
Cod. 69.011  
LOCK KIT



CityCrash



> *clap.infinity*

# Caratteristiche Features



LA BARRA TELESCOPICA  
The Telescopic roof bars

**MATERIALE/MATERIAL**

Alluminio/Aluminium



**CODICE/CODE**

60.300  
8010682052664 (EAN)



**MISURE/MEASURES**

77 - 115 cm (lunghezza/length)



**CARICO MAX./MAX LOAD**

75 Kg



**SERRATURA/LOCK**

Cod. 69.011

# Barre porta tutto Roof bars

Garantie  
**2**  
years

QUALITY  
TEST  
ISO PAS 11154

**EASYFIX**

**75 Kg**  
MAX LOAD

**2**  
PCS

Cod. 69.011  
**LOCK KIT**



CityCrash



> *clap.infinity*

# Caratteristiche Features



**LA BARRA TELESCOPICA**  
The Telescopic roof bars

**MATERIALE/MATERIAL**

Acciaio/Steel



**CODICE/CODE**

61.300  
8010682050486 (EAN)



**MISURE/MEASURES**

77 - 115 cm (lunghezza/length)



**CARICO MAX./MAX LOAD**

75 Kg



**SERRATURA/LOCK**

Opzionale/Optional  
(cod. 69.011)



# Barre porta tutto Roof bars

Garanzie  
**2**  
years

QUALITY  
TEST  
ISO PAS 11154

 EASYFIX

**75 Kg**  
MAX LOAD

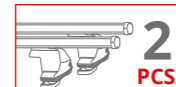
 **2**  
PCS

 included  
Cod. 69.011  
LOCK KIT



CityCrash



> *clap.airflow*

# Caratteristiche Features



**INNOVAZIONE ED ELEGANZA**  
Elegance and Innovation

**MATERIALE/MATERIAL**  
Alluminio/Aluminium



**CODICE/CODE**

60.210  
8010682050493 (EAN)



**MISURE/MEASURES**

110 cm (lunghezza/length)



**CARICO MAX./MAX LOAD**

75 Kg



**SERRATURA/LOCK**

Cod. 69.011



**TAPPO/CAP**

K60.012G3



## Caratteristiche Features



**INNOVAZIONE ED ELEGANZA**  
Elegance and Innovation



### MATERIALE/MATERIAL

Alluminio/Aluminium



### CODICE/CODE

60.230  
8010682050509 (EAN)



### MISURE/MEASURES

127 cm (lunghezza/length)



### CARICO MAX./MAX LOAD

75 Kg



### SERRATURA/LOCK

Cod. 69.011



### TAPPO/CAP

K60.012G3



**“Non si può descrivere la passione, la si può solo vivere”**

We can not describe passion, we can only live it.

(E.FERRARI)





# Accessori Barre Bars accessories

Più spazio ai vostri viaggi *More space for your journeys*





## Accessori Barre Bars accessories

> *tappi caps*

Tappo standard | Standard cap



**CODICE/CODE**  
K60.309G3  
8010682048926 (EAN)

Tappo flex completo | Complete flex cap



**CODICE/CODE**  
K60.013G3  
8010682052121 (EAN)



## Accessori Barre Bars accessories

> *tappi caps*

Tappo flex a goccia completo | Full drop flex cap



**CODICE/CODE**  
K60.012G3  
8010682052091 (EAN)

> *sacca bag*



Consente di prendersi cura delle barre una volta smontate.

It allows to take care of your bars once disassembled.



**CODICE/CODE**  
69.900  
8010682043136 (EAN)



## Accessori Barre Bars accessories

> *serrature locks*

### Kit serratura corta | Short lock kit



Serratura di ricambio per tutte le barre G3 ad eccezione delle Pacific.

Replacing lock for all G3 bars except Pacific



**CODICE/CODE**

69.011  
8010682041835 (EAN)

### Kit serratura lunga | Long lock kit



Serratura di ricambio esclusivamente per barre Pacific.

Replacing lock for Pacificbars only.



**CODICE/CODE**

69.015  
8010682051681 (EAN)



## Accessori Barre Bars accessories

> *serrature locks*

### Serratura in plastica | Plastic lock



Serratura in plastica adatta a tutte le barre G3 in acciaio.

Plastic lock suitable to all G3 steel bars.



**CODICE/CODE**

AT.317  
8010682053012 (EAN)

> *Kit barre bars kit*

### Kit fissaggio a "T" | T-Shaped Fixing Kit

L = 25 mm  
D = 19 mm  
H = 5,5 mm



Consente di fissare qualsiasi accessorio sulle barre in alluminio in modo sicuro e invisibile.

It allows you to fix any accessory on the aluminum bars in a safe and invisible way.



**CODICE/CODE**

K9.041.02  
8010682048131 (EAN)

## Accessori Barre Bars accessories

> *Kit barre bars kit*

### Kit cover pacific basic | Pacific basic cover kit



Kit cover utilizzabile con barre Pacific.basic e Pacific.basickitless

Cover kit for Pacific.basic and Pacific.basickitless bars



**CODICE/CODE**

69.014  
8010682050349 (EAN)

### Kit adattatore rotante | Balancing support kit



Posiziona parallelamente al terreno anche barre montate su vetture con tetto spiovente.

It also places bars mounted on cars with a sloping roof parallel to the ground.



**CODICE/CODE**

69.013  
8010682046687 (EAN)

## Accessori Barre Bars accessories

> *espositore display*

### Espositore barre | Bars display



**CODICE/CODE**

60.999  
8010682053067 (EAN)



G3 + PERUZZO  
LIVE YOUR EMOTIONS





## Caratteristiche Features

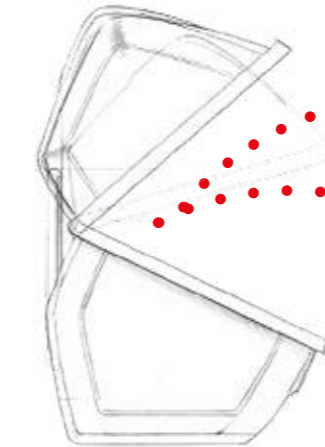
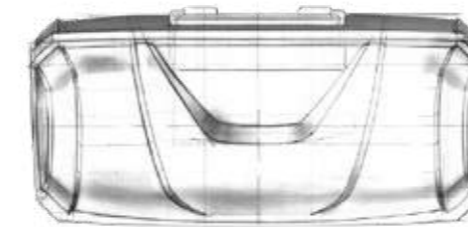
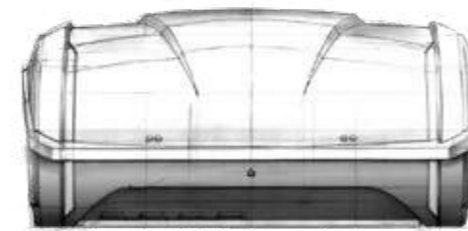

**SPAZIO EXTRA**  
Extra space



**PORTABICI SU CUI MONTA**  
Bike carriers on which it mounts

- Zephyr • Pure Instinct
- Siena (3/4 bici - 3/4 bikes)
- Parma (3/4 bici - 3/4 bikes)

### MISURE/MEASURES



130 x 63 x 60 cm

### CAPACITA'/CAPACITY



340 lt

### CARICO MAX./MAX LOAD



45 Kg





## IL NOSTRO VIAGGIO INSIEME INIZIA DA QUI...

### Automechanika 2018:

Gli stand di **G3 Spa** e **Peruzzo srl** non erano molto vicini ma già palesavano la possibilità di una perfetta integrazione: barre e box da un lato e portabici dall'altro. Nacque così il primo incontro, e da subito fu chiara l'opportunità di creare, unendo le forze, quello che oggi si appresta ad essere il punto di riferimento per il portaggio, completamente Made in Italy.

## OUR JOURNEY TOGETHER STARTS HERE...

### Automechanika 2018:

The stands of **G3 Spa** and **Peruzzo srl** were not so close together, however we had already seen the potential of what a perfect partnership could be. On one side rooftop boxes and on the other cycle carriers. From this first meeting it was very clear that this opportunity to work together to create products of quality and reference in the marketplace. All completely Made In Italy.



## IL NOSTRO BOX DA GANCIO TRAINO

Da qui nasce il nostro primo prodotto a marchio **GP**: frutto del Know-how dei nostri tecnici.

Il **design moderno e la grande capienza** permettono di trasformare i nostri portabici in un pratico portapacchi: ideale per trasportare tutto il necessario durante i tuoi viaggi!

Design italiano e versatilità contraddistinguono il nuovo box. **Live your Emotions!**

## OUR STORAGE BOX FOR TOWBALL CARRIERS

The GP Brand is Born. Today we have created our first product, conceived from the know-how and expertise of our technicians.

Box GP with **its modern design and large capacity**, allowing you to transform your cycle carrier into a practical load carrier for your vehicle. Ideal for carrying that little extra during your travels.

Stylish Italian design distinguishes the Box GP helping you **live your emotions** on the open road.



G3+ PERUZZO  
LIVE YOUR EMOTIONS

